



HP Networking Switches with VPN Firewall

FIPS 140-2 Non-Proprietary Security Policy

Level 2 Validation

Version 1.02

April 2013

Revision Record

Date	Revision Version	Change Description	Author
2012-03-18	1.01	Initial	HP
2013-04-26	1.02	Updated 12500 information to include all models	HP

Table of Contents

1 Introduction	7
2 Overview	7
2.1 Modular Ethernet Switches	7
2.1.1 HP 7500 Switch Series.....	7
2.1.2 HP 9500 Switch Series.....	10
2.1.3 HP 12500 Switch Series.....	12
3 Security Appliance Validation Level	16
4 Physical Characteristics and Security Appliance Interfaces	17
4.1 Modular Ethernet switches.....	17
4.1.1 HP 7500 Switch Series.....	17
4.1.2 HP 9500 Switch Series.....	18
4.1.3 HP 12500 Switch Series.....	18
4.2 Physical Interfaces Mapping	19
5 Roles, Services, and Authentication	19
5.1 Roles	19
5.2 Services	20
5.3 Authentication Mechanisms	23
6 Approved Cryptographic Algorithms	24
7 Non-approved Cryptographic Algorithms	24
8 Cryptographic Key Management	25
8.1 Access Control Policy	26
9 Self-Tests	28
9.1 Power-On Self-Tests.....	28
9.2 Conditional Self-Tests.....	29
10 Delivery and Operation	29
10.1 Secure Delivery.....	29
10.2 Secure Operation.....	30
11 Physical Security Mechanism	30
12 Mitigation of Other Attacks	33
13 Documentation References	33
13.1 Obtaining documentation	33

13.2 Technical support..... 33

FIPS 140-2 Non-Proprietary Security Policy for the HP Networking Switches

Keywords: Security Policy, CSP, Roles, Service, Cryptographic Module

List of abbreviations:

Abbreviation	Full spelling
AAA	Authentication, Authorization, and Accounting
AES	Advanced Encryption Standard
CF	Compact Flash
CLI	Command Line Interface
CMVP	Cryptographic Module Validation Program
CSP	Critical Security Parameter
DES	Data Encryption Standard
DOA	Dead on arrival
FCoE	Fibre Channel over Ethernet
FIPS	Federal Information Processing Standard
HMAC	Hash-based Message Authentication Code
HTTP	Hyper Text Transfer Protocol
IRF	Intelligent Resilient Framework
KAT	Known Answer Test
LED	Light Emitting Diode
LPU	Line Processing Unit
MAC	Message Authentication Code
MAN	Metropolitan Area Network
MPU	Main Processing Unit
NIST	National Institute of Standards and Technology
OAA	Open Application Architecture
OAP	Open Application Platform
PSU	Power Supply Unit
RADIUS	Remote Authentication Dial In User Service
RAM	Random Access Memory
RSA	Rivest Shamir and Adleman method for asymmetric encryption
SFP	Small Form-Factor Pluggable
SFP+	Enhanced Small Form-Factor Pluggable
SHA	Secure Hash Algorithm

Abbreviation	Full spelling
SRPU	Switching and routing processor unit
SSL	Secure Sockets Layer
TLS	Transport Layer Security
XFP	10 Gigabit Small Form-Factor Pluggable

1 Introduction

This document is a non-proprietary Cryptographic Module Security Policy for HP Networking Switches with VPN Firewall Blade. The series includes modular Ethernet switches (HP 7500, HP 9500, HP 12500). The policy describes how the HP Networking switches meet the requirements of FIPS 140-2. This document also describes how to configure HP Networking switches in FIPS 140-2 mode. This document was prepared as part of the Level 2 FIPS 140-2 validation.

FIPS 140-2 standard details the U.S. Government requirements for cryptographic security appliances. More information about the standard and validation program is available on the NIST website at <http://csrc.nist.gov/groups/STM/cmvp/>

This document includes the following sections:

- Overview
- Security Appliance Validation Level
- Physical Characteristics and Security Appliance Interfaces
- Roles, Services and Authentication
- FIPS Approved Algorithms
- Non-FIPS Approved Algorithms
- Cryptographic Key Management
- Self-Tests
- Delivery and Operation
- Physical Security Mechanism
- Mitigation of Other Attacks
- Obtaining Documentation and Technical Assistance

2 Overview

The HP Networking provides devices are suitable for a range of uses: at the edge of a network, connecting server clusters in a data center, in an enterprise LAN core, and in large-scale industrial networks and campus networks. The series includes fixed-port L2/L2+ managed Ethernet switch appliances, fixed-port L3 managed Ethernet switch appliances, and modular Ethernet switches. Each device is based on the Comware 5.2 platform.

2.1 Modular Ethernet Switches

2.1.1 HP 7500 Switch Series

The HP 7500 Switch Series comprises 10-Gigabit modular core switches designed for the requirements of enterprise data center applications. These multilayer switches meet the evolving needs of integrated services networks, and can be deployed in multiple network environments, including the enterprise LAN core, aggregation layer, and wiring closet edge, as well as in metropolitan area networks (MANs) and data centers. They feature cost-effective wire-speed 10 Gigabit Ethernet ports to provide the throughput and bandwidth necessary for mission-critical data and high-speed communications. A passive backplane, support for load

sharing, and redundant management and fabrics help HP 7500 series switches offer high availability. Moreover, these switches deliver wire-speed Layer 2 and Layer 3 routing services for the most demanding applications.

Testing included six models in the 7500 series:

- HP 7510
- HP 7506
- HP 7506V
- HP 7503
- HP 7502
- HP 7503-S

Figure 1 shows a representative of the series. This series is illustrated below with 24 Tamper-evident labels and 3 opacity shields, 23 Tamper-evident labels and 2 opacity shields, 29 Tamper-evident labels and 2 opacity shields, 38 Tamper-evident labels and 5 opacity shields, and 39 Tamper-evident labels and 2 opacity shields, dependent on the number of card slots when configured as shown in Figure 1.

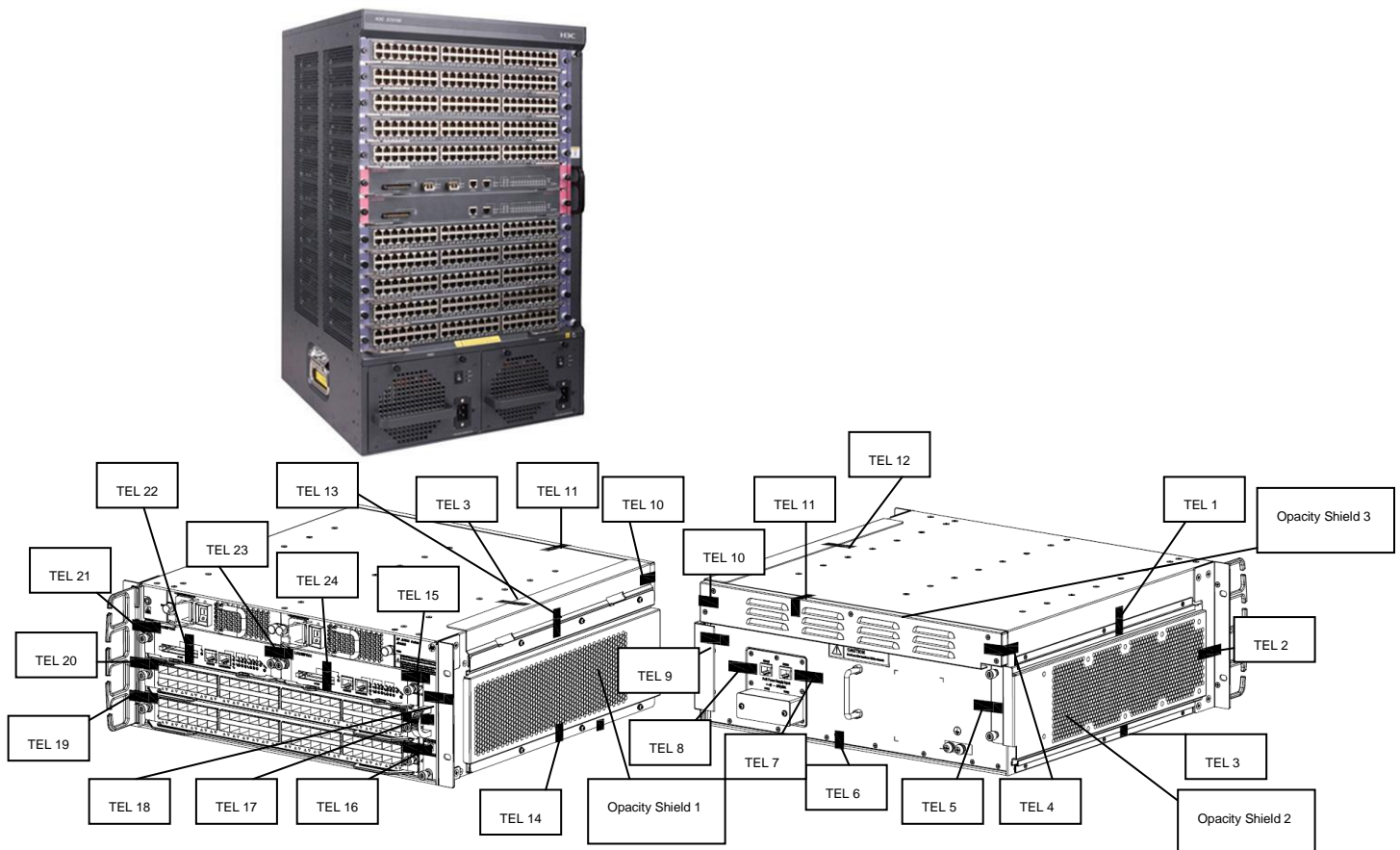

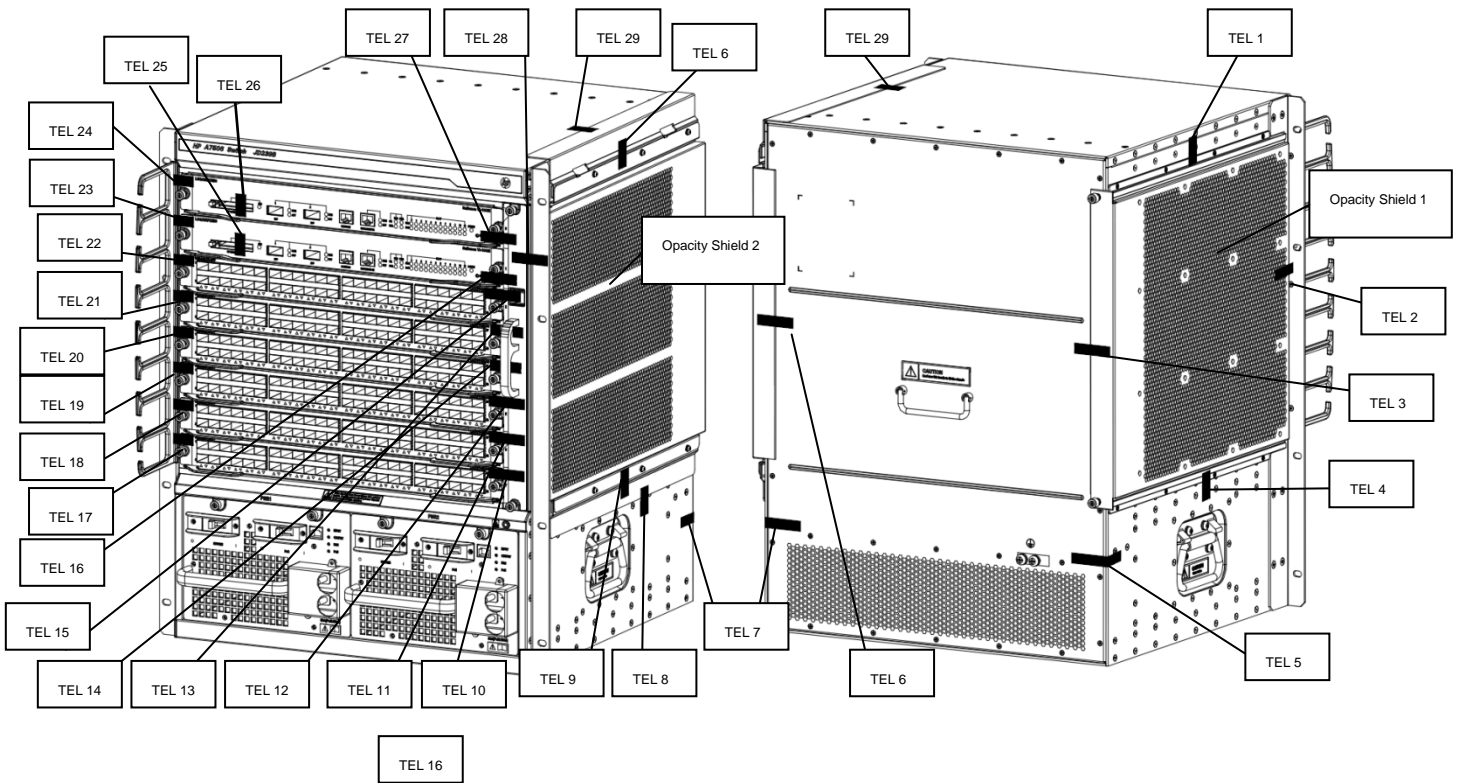
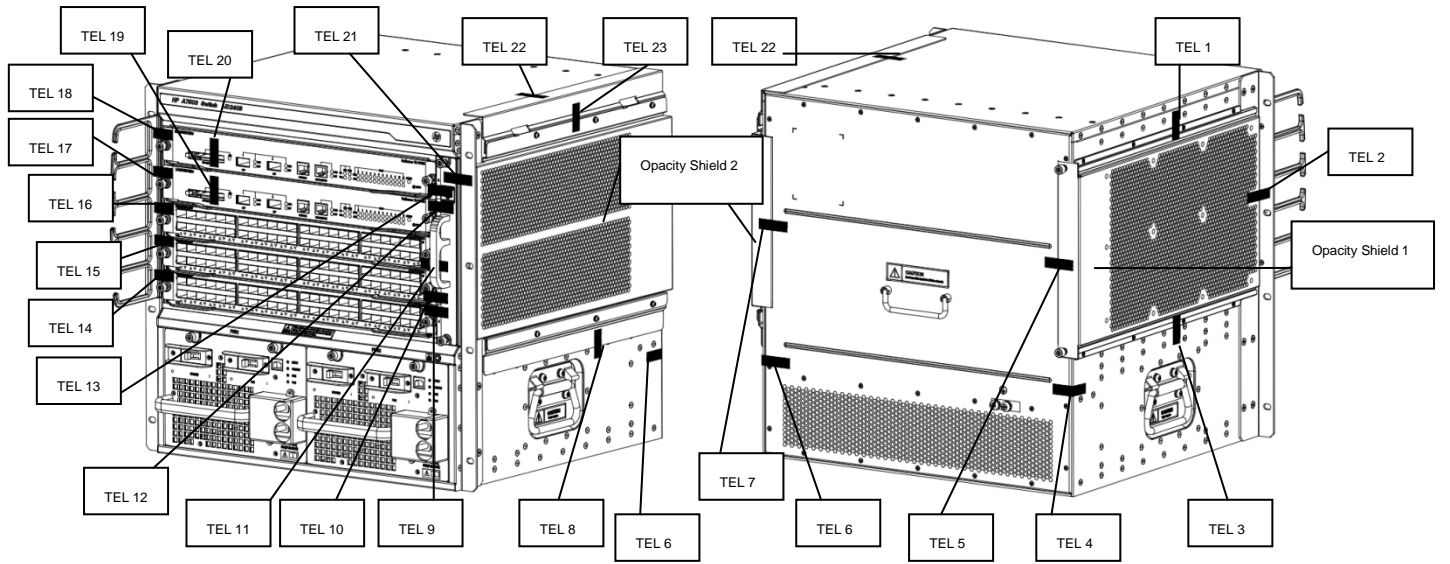

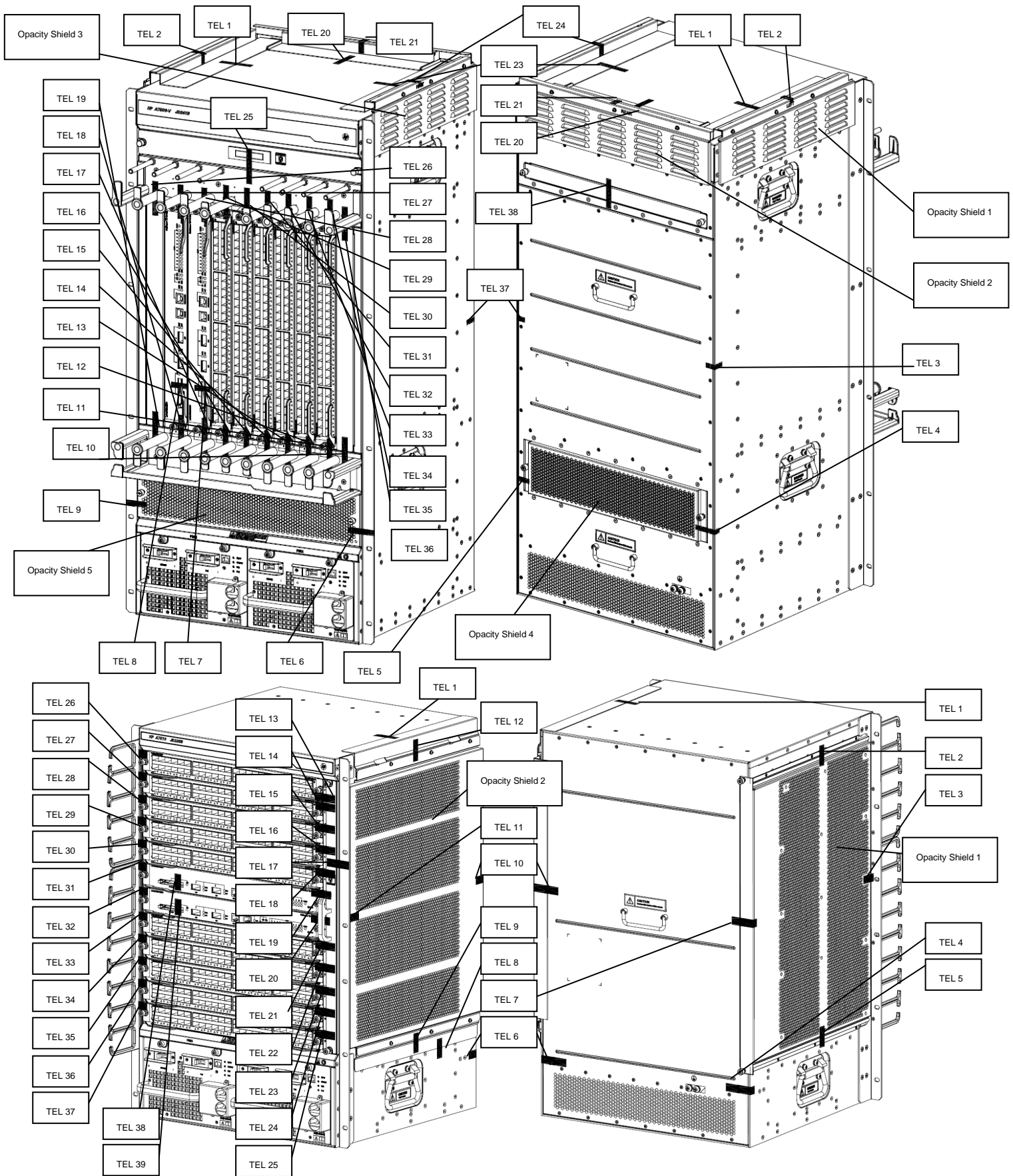

Figure 1 HP 7500 Switch Series Representative View

2.1.2 HP 9500 Switch Series

The HP 9500 Switch Series are modular switches that form a next-generation data center/large campus core switching platform. With unprecedented levels of networking performance,

industry-leading availability, and flexible and efficient deployment options, these switches enable new services while driving down the cost of network operations. The 9500 series switches can provide more than 1.4 TB of high-performance switching capacity, aggregate up to 192 10-Gigabit Ethernet or 576 Gigabit Ethernet ports, and offer a future-proof architecture that enables customers to support emerging enterprise core or data center requirements.

Testing included three models in the series:

- HP 9505
- HP 9508V
- HP 9512

Figure 2 shows a representative of the series. This series requires 39 Tamper-evident labels and 3 opacity shields, 47 Tamper-evident labels and 3 opacity shields, and 54 Tamper-evident labels and 3 opacity shields for the modules when configured as shown in Figure 2.

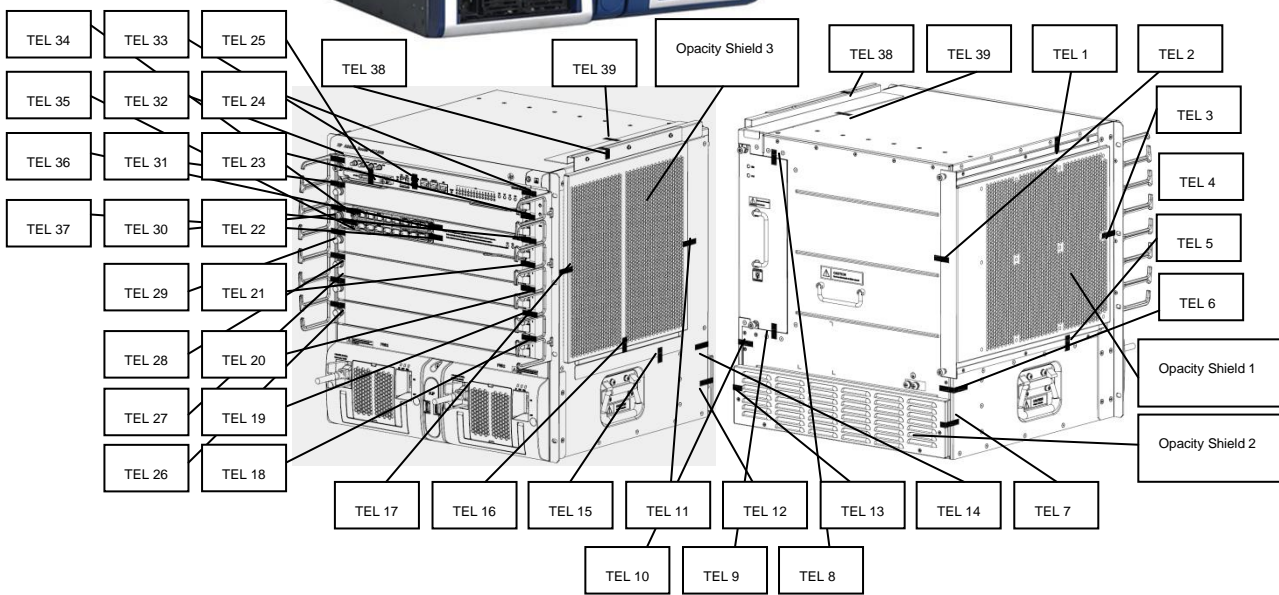

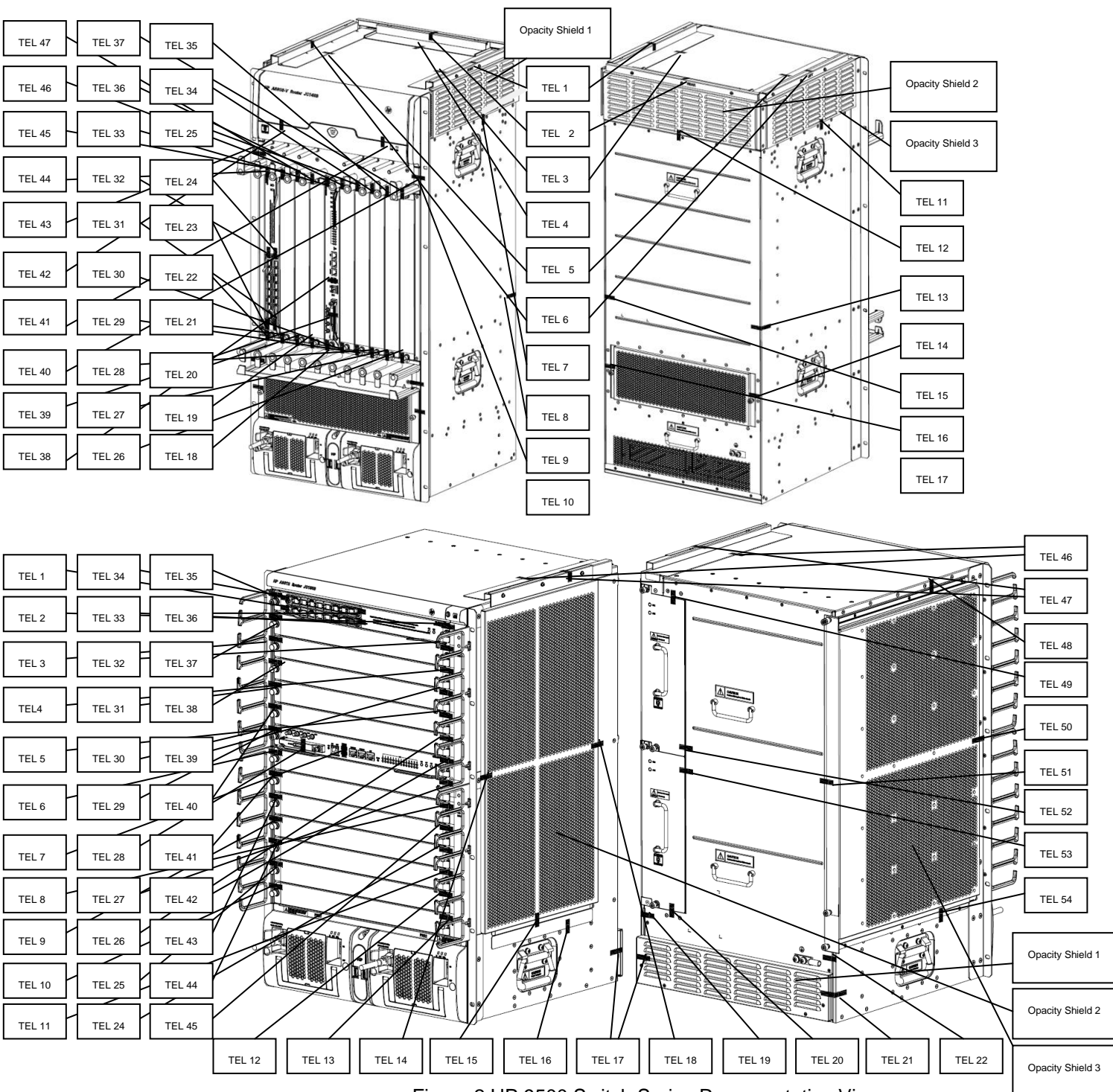

Figure 2 HP 9500 Switch Series Representative View

2.1.3 HP 12500 Switch Series

The HP 12500 Switch series comprises a pair of powerful, next-generation routing switches with outstanding capacity for the network core or the data center. Besides innovative IRF technology that provides unprecedented levels of performance and high availability, HP 12500 series switches incorporate the OAA, which enables flexible deployment options for new services. These switches also have energy-efficiency features that drive down operational expenses. The 12500 series is ideal for organizations contemplating large-scale data center or campus consolidations, business continuity and disaster recovery sites, metropolitan area network deployments, and other applications requiring a robust, high-performance switching platform.

- Advanced multi-level, multi-plane non-blocking switching architecture.

- Ultra-high port density and support for multiple interface types including the XFP 10-Gigabit Ethernet optical interface, SFP Gigabit Ethernet optical interface, and 10/100/1000 Mbps electrical interface.
- Future-proof design, allowing the series to provide in the future value-added security services like firewall, IPSec, and LB to meet the requirements of intelligent IP networks.

The 12500 series are mainly deployed at:

- Core layer and distribution layer of large-scale data centers (DCs)
- Core layer of large-scale industry networks and campus networks
- Large clusters and grid computing

Testing included three models in the 12500 series:

- HP 12504
- HP 12508
- HP 12518

Figure 3 shows a representative of the series. This series requires 22 Tamper-evident labels and 43 Tamper-evident labels for the modules when configured as shown in Figure 3



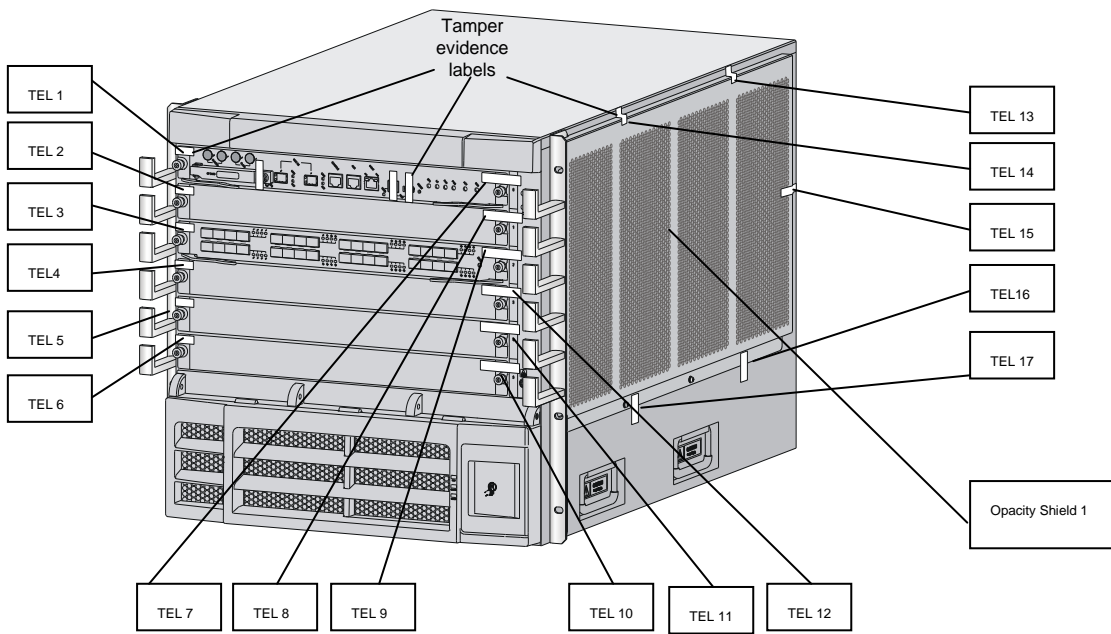

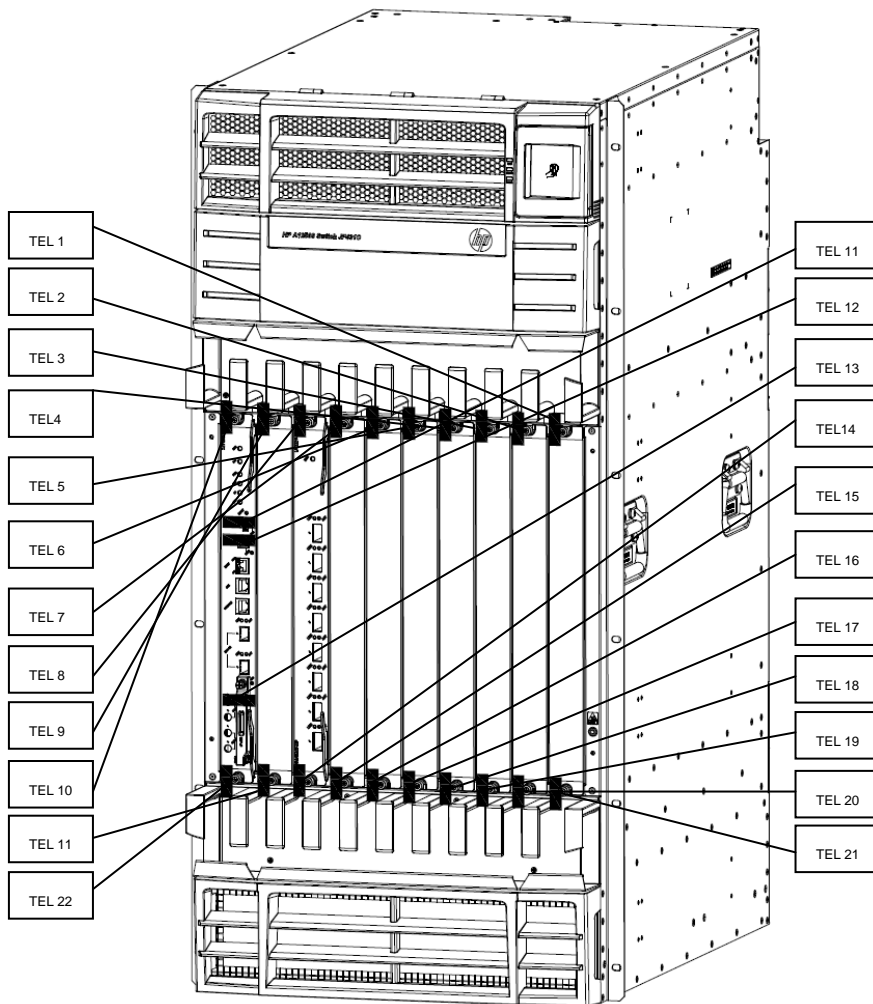

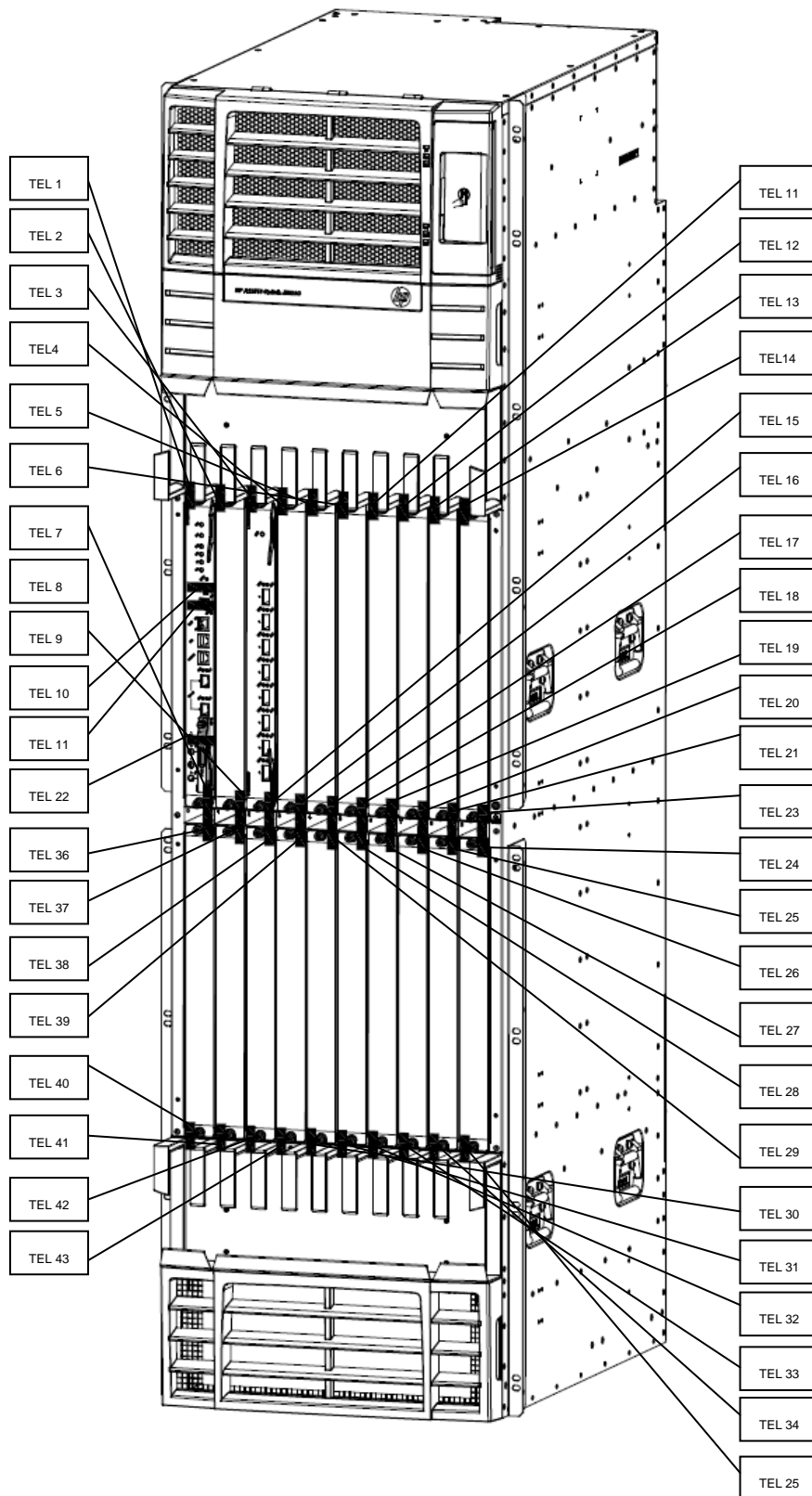

Figure 3 HP 12500 Switch Series Representative View

3 Security Appliance Validation Level

Table 1 lists the level of validation for each area in the FIPS PUB 140-2.

Table 1 Validation Level by Section

No.	Area	Level
1	Cryptographic Module Specification	2
2	Cryptographic Module Ports and Interfaces	2
3	Roles, Services, and Authentication	2
4	Finite State Model	2
5	Physical Security	2
6	Operational Environment	N/A
7	Cryptographic Key management	2
8	Electromagnetic Interface/Electromagnetic Compatibility	2
9	Self-Tests	2
10	Design Assurance	2
11	Mitigation of Other Attacks	N/A

4 Physical Characteristics and Security Appliance Interfaces

4.1 Modular Ethernet switches

Each modular Ethernet switch is a multi-chip standalone security appliance. The cryptographic boundary is defined as encompassing the “top,” “front,” “left,” “right,” “rear”, and “bottom” surfaces of the integrated chassis. The general components of each modular Ethernet switch include firmware and hardware which are placed in the three-dimensional space within the chassis.

The modular Ethernet switches use a distributed architecture, which comprises the chassis, power module, fan, backplane, main processing units (MPUs), and line processing units (LPUs). A MPU is the core of a switch. It implements the following features:

- Calculate routes and maintain forwarding tables,
- Provide data exchange between LPUs (7500 and 9500),
- Provide system configuration and functions to monitor other boards as well as upgrade and reset board software,
- Support active/standby switchover.

4.1.1 HP 7500 Switch Series

HP 7500 chassis accommodate two, three, six or ten LPUs. LPUs provide Gigabit Ethernet, SFP Gigabit, and XFP 10-Gigabit ports in a range of numbers and combinations. The series

supports a maximum of 480 Gigabit Ethernet ports or 480 SFP Gigabit ports, and 84 XFP 10-Gigabit ports. Each LPU has LEDs to indicate port status.

In addition, each 7500 switch requires a MPU¹. The chassis have two MPU slots (except for model 7503-S, which has one). Each MPU provides a serial console port and a 100 Mbps Ethernet port for management. MPUs provide additional combinations of ports including Gigabit Ethernet, SFP Gigabit, and XFP 10-Gigabit ports as well a compact flash (CF) card slot (Type I or II). The MPUs have status LEDs for LPUs, management port, network ports, CF, power, and fan tray status reporting. Each MPU has a reset button.

Each chassis has two slots for power modules. Each power module has a power input (AC or DC), a system power switch, and power LED. Some power modules provide PoE along with a PoE power switch, PoE status LEDs, and a console port to monitor PoE. The 7502 and 7503-S chassis provide inputs for external PoE power supplies together with monitoring ports (RS-485 and RS-232).

http://h17007.www1.hp.com/us/en/products/switches/HP_7500_Switch_Series/index.aspx

describes MPU options, LPU options, and ports in detail along with the interpretation of the LEDs

4.1.2 HP 9500 Switch Series

HP 9500 chassis accommodate five, eight or twelve LPUs. LPUs provide Gigabit Ethernet, SFP Gigabit, SFP+ 10-Gigabit, and XFP 10-Gigabit ports in a range of numbers and combinations. The series supports a maximum of 576 Gigabit Ethernet ports or 576 SFP Gigabit ports, and 192 SFP+ 10-Gigabit ports. Each LPU has LEDs to indicate port status.

In addition, each 9500 switch requires a MPU. The chassis have two MPU slots. Each MPU provides a 100 Mbps Ethernet management port, a serial management port, an auxiliary serial port, two USB ports (host and device), and a CF card slot. (The MPU have reserved ports, which are not supported at present (a RS-232/485 port and standby main board coaxial clock interfaces).) The MPU have status LEDs for MPU, LPUs, management port, USB ports, and CF status reporting. Each MPU has a reset button.

Each chassis has two slots for AC or DC power supply units (PSU). An AC PSU has slots for two sub-PSUs along with a switch for each sub-PSU. An AC sub-PSU has AC input and power LEDs. A DC PSU has power input, power switch, and status LEDs.

http://h17007.www1.hp.com/us/en/products/switches/HP_9500_Switch_Series/index.aspx#tab2

describes MPU options, LPU options, and ports in detail along with the interpretation of the LEDs.

4.1.3 HP 12500 Switch Series

HP 12500 chassis accommodate eight or eighteen LPUs. LPUs provide Gigabit Ethernet, SFP Gigabit, SFP+ 10-Gigabit, and XFP 10-Gigabit ports in a range of numbers and combinations. The series supports a maximum of 864 Gigabit Ethernet ports or 864 SFP Gigabit ports, and 512 SFP+ 10-Gigabit ports. Each LPU has LEDs to indicate port status.

In addition, each 12500 switch requires a MPU. The chassis have two MPU slots. Each MPU provides a 100-Mbps Ethernet management port, a serial management port, an auxiliary serial port, two USB ports (host and device), and a CF card slot. (The MPUs have reserved ports, which are not supported at present (a RS-232/485 port, standby main board coaxial clock

¹ MPU are also known and switching and routing processing unit (SRPU) for 7500 switches.

interfaces, and MCC Gigabit Ethernet interfaces.) The MPUs have status LEDs for switching fabric modules, LPU, fan, power, MPU, and CF status reporting. Each MPU has a reset button.

Chassis power is provided through AC power frames (one for model 12405,12508, and two for model 12518). Each AC power frame accommodates up to six hot-swappable 1U AC PSU. The frame as status LED and a power frame switch. A power entry module supplies power input to each PSU.

http://h17007.www1.hp.com/us/en/products/switches/HP_12500_Switch_Series/index.aspx#tab_2 describes MPU options, LPU options, and ports in detail along with the interpretation of the LEDs.

4.2 Physical Interfaces Mapping

The physical interfaces provided by the HP Networking switches map to four FIPS 140-2 defined logical interface: data input, data output, control input and status output. Table 1 presents the mapping.

Table 1 Correspondence between Physical and Logical Interfaces

Physical Interface	FIPS 140-2 Logical Interface
Networking ports	Data Input Interface
Console port	
Management Ethernet port	
CF card slot	
Networking ports	Data Output Interface
Console port	
Management Ethernet port	
CF card slot	
Networking ports	Control Input Interface
Console port	
Management Ethernet port	
Power switches	
Reset Switch	
Port status LED mode switching button	Status Output Interface
Networking ports	
Console port	
Management Ethernet port	
LEDs	Power Interface
Power Slot	
Backplane	Unused Interface
USB ports	
AUX port	
SMB coaxial clock interfaces	
RS-232/485 interfaces	

5 Roles, Services, and Authentication

5.1 Roles

The HP Networking switches provide four roles: Visit, Monitor, Config, and Manage. Roles Visit, Monitor, and Config correspond to the FIPS 140-2 User Role. The Manage role corresponds to the FIPS 140-2 Crypto Officer role. The devices allow multiple management users to operate the appliance simultaneously.

The HP Networking switches do not employ a maintenance interface and do not have a maintenance role.

5.2 Services

HP Networking switches provide six classes of services:

- View device status,
- Network functions,
- Security management,
- Review the audit trail,
- View running status, and
- Configure the security appliance.

You can access these services by using any of the following methods:

- Console Port
- SSH
- Web user interface via HTTPS

The console port and SSH present a command line interface while the web user interface is a graphical user interface. The following table lists services available to each role within each class of service. The role in the brackets is the corresponding role specified in FIPS 140-2. HP Networking switches do not support bypass (that is, services provided without cryptographic processing).

Table 2 Services by Role

Role	Privilege level	Services
Visit [User role]	0	1) View device status: Currently running image version; Installed hardware components status and version. 2) Network functions: Network diagnostic service such as “ping”; Network connection service such as “SSH” client. 3) Security management: Change the privilege level.
Monitor [User role]	1	1) View device status: Currently running image version; Installed hardware components status and version 2) Network functions: Network diagnostic service such as “ping”; Network connection service such as “SSH” client. 3) Security management: Change the privilege level. 4) Review the audit trail;
Config [User role]	2	1) View device status: Currently running image version;

Role	Privilege level	Services
		<p>Installed hardware components status and version</p> <p>2) Network functions: Network diagnostic service such as “ping”; Network connection service such as “SSH” client.</p> <p>3) Security management: Change the privilege level; Reset and change the password of same/lower privilege user; Maintenance of the super password; Maintenance (create, destroy, import, export) of public key/private key/shared key.</p> <p>4) Review the audit trail</p> <p>5) View running status: Memory status, Packet statistics, Interface status, Current running Image version, Current configuration, Routing table, Active sessions, Temperature, SNMP MIB statistics.</p> <p>6) Configure the security appliance: Save configuration; Management of information center (start-up and shut down audit functions; setting logbuffer, setting logfile; setting log output destination); Managing (create, modify, delete apply) the filtering rules; Management of firewall; Define network interfaces and settings; Set the protocols the security appliance will support; enable interfaces and network services.</p>
Manage [Crypto Officer role]	3	<p>1) View device status: Currently running image version; Installed hardware components status and version</p> <p>2) Network functions: Network diagnostic service such as “ping”; Network connection service such as “SSH” client.</p>

Role	Privilege level	Services
		<p>3) Security management: Change the privilege level; Reset and change the password of same/lower privilege user; Maintenance of the super password; Maintenance (create, destroy, import, export) of public key/private key/shared key; Shut down or Reboot the security appliance; Management (create, delete, modify) of the user group; Management (create, delete, modify) of the user account; Management of the time; Maintenance (delete, modify) system start-up parameters; File operation (e.g. dir, copy, del); Management of the command privilege; Install or remove HP Networking Security Appliance.</p> <p>4) Review the audit trail;</p> <p>5) View running status: Memory status, Packet statistics, Interface status, Current running image version, Current configuration, Routing table, Active sessions, Temperature, SNMP MIB statistics.</p> <p>6) Configure the security appliance: Save configuration; Management of information center (start-up and shut down audit functions; setting logbuffer, setting logfile; setting log output destination delete of the audit trail.); Managing (create, modify, delete apply) the filtering rules; Management of firewall; Define network interfaces and settings; Set the protocols the security appliance will support (e.g. SFTP server, SSH server);</p>

Role	Privilege level	Services
		enable interfaces and network services; Management of access control scheme (e.g. domain and RADIUS scheme).

http://h17007.www1.hp.com/us/en/products/switches/HP_12500_Switch_Series/index.aspx#tab_2 provides details of the commands that provide the services listed in Table 2. http://h17007.www1.hp.com/us/en/products/switches/HP_12500_Switch_Series/index.aspx#tab_2) presents the corresponding web user interface.

5.3 Authentication Mechanisms

HP Networking switches support both role-based and identity-based authentication.

- Identity-based authentication

Each user is authenticated upon initial access to the device. The authentication is identity-based. All users can be authenticated locally, and optionally supports authentication via a RADIUS and TACACS+ server.

To logon to the appliances, an operator must connect to it through one of the management interfaces (console port, SSH, HTTPS) and provide a password.

- Role-based authentication

Each User can switch to a different user privilege level without logging out and terminating the current connection. To switch to a different privilege level, a user must provide the privilege level switching authentication information. The authentication is role-based. All users can be authenticated locally, and optionally supports authentication via a RADIUS and TACACS+ server.

After the privilege level switching, users can continue to manage the device without relogging in, but the commands they can execute have changed. For example, with the user privilege level 3, a user can configure system parameters as crypto officer role. After switching to user privilege level 0, the user can execute only basic commands like ping and tracert and use a few display commands as user role.

Operators must be authenticated using user names and passwords. The passwords must:

- 1) Be a minimum of six characters long, and the maximum password size is 63.
- 2) Be a combination of alphabetic and numeric characters.

- 3) Contain punctuation characters.
- 4) Contain lower and upper case characters.

The probability of a false positive for a random password guess is less than 1 in 1,000,000. This is also valid for RADIUS or TACACS+ shared secret keys

The users who try to log in or switch to a different user privilege level can be authenticated by RADIUS and TACACS+ Server. The device (RADIUS client) and the RADIUS server use a shared key to authenticate RADIUS packets and encrypt user passwords exchanged between them. For more details, see RFC 2865: 3 Packet Format Authenticator field and 5.2 User-password

6 Approved Cryptographic Algorithms

Table 3 lists the FIPS-Approved algorithms HP Networking switches provide.

Table 3 FIPS-Approved Cryptography Algorithms

Algorithm	Application	Certificate
AES	Encryption/decryption	1927
Triple-DES	Encryption/decryption	1254
SHA-1	SHA-1 hashing	1692
SHA-256	SHA-256 hashing	1692
HMAC SHA1	SHA-1 HMAC for hashed message authentication	1161
HMAC SHA256	SHA-256 HMAC for hashed message authentication	1161
RSA	Signing and verifying	993
DSA	Signing and verifying	611
X9.31 for RNG	Random number generation	1014

7 Non-approved Cryptographic Algorithms

HP Networking switches provide additional cryptographic algorithms that are not FIPS Approved:

- DES
- RC4
- MD5
- MD5 HMAC

- RSA (key wrapping; key establishment methodology provides 80 or 112 bits of encryption strength)
- Diffie-Hellman (key agreement; key establishment methodology provides 80 or 112 bits of encryption strength)

8 Cryptographic Key Management

The security appliances use a variety of Critical Security Parameters (CSP) during operation. Table 4 lists the CSP including cryptographic keys used by the HP Networking security switches. It summarizes generation, storage, and zeroization methods for the CSP.

Table 4 Cryptographic Security Parameters

#	Key/ CSP Name	Generation/ Algorithm	Description	Storage	Zeroization
CSP1	RSA public/ private keys	ANSI X9.31/RSA	Identity certificates for the security appliance itself and also used in TLS and SSH negotiations. The security appliance supports 1024 ~ 2048 bit key sizes.	Private Key-FLASH (cipher text/Triple-DES) and RAM (plain text) Public Key-FLASH (cipher text/ Triple-DES) and RAM (plain text)	Private Key - Using CLI command to zeroize, then reboot. Public Key - Using CLI command to zeroize, then reboot.
CSP2	DSA public/ private keys	ANSI X9.31/DSA	Identity certificates for the security appliance itself and also used in SSH negotiations.	Private Key-FLASH (cipher text/Triple-DES) and RAM (plain text) Public Key-FLASH (cipher text/Triple-DES) and RAM (plain text)	Private Key-Using CLI command to zeroize, then reboot. Public Key - Using CLI command to zeroize, then reboot.
CSP3	Diffie-Hellman Key Pairs	ANSI X9.31 / DH	Key agreement for TLS, and SSH sessions.	RAM (plain text)	Resetting or rebooting the security appliance.
CSP4	Public keys	DSA / RSA	Public keys of peers	FLASH(plain text)/ RAM (plain text)	Delete public keys of peers from configuration, write to startup config, then reboot
CSP5	TLS Traffic Keys	Generated using the TLS protocol (X9.31PRNG + HMAC-SHA1 + either DH or RSA) Algorithm: Also Triple-DES & AES	Used in HTTPS connections	RAM (plain text)	Resetting or rebooting the security appliance.
CSP6	SSH Session Keys	ANSI X9.31 / Triple-DES-AES	SSH keys	RAM (plain text)	Resetting or rebooting the security appliance

#	Key/ CSP Name	Generation/ Algorithm	Description	Storage	Zeroization
CSP7	IPSec authentication keys	Triple-DES-AES	Triple-DES or AES Keys are manually configured for IPv6 routing protocol such as OSPFv3, RIPng, IPv6 BGP.	FLASH(plain text) /RAM (plain text)	Delete IPSec keys from configuration, write to startup config, then reboot
CSP8	IPSec traffic keys	Triple-DES-AES	Triple-DES or AES Keys are manually configured for IPv6 routing protocol such as OSPFv3, RIPng, IPv6 BGP.	FLASH(plain text)/ RAM (plain text)	Delete IPSec keys from configuration, write to startup config, then reboot
CSP9	RADIUS shared secret keys	Shared Secret	Used for authenticating the RADIUS server to the security appliance and vice versa. Entered by the Crypto-Officer in plain text form and stored in plain text form.	FLASH (plain text) and RAM (plain text)	Deleting keys from the configuration via erase flash: command (or replacing), write to startup config, then reboot.
CSP10	Username/ Passwords/ super password	Secret	Critical security parameters used to authenticate the administrator login or privilege promoting.	FLASH (plain text) and RAM (plain text)	Overwriting the passwords with new ones, write to startup config, then reboot.
CSP11	Certificates of Certificate Authorities (CAs)	ANSI X9.31	Necessary to verify certificates issued by the CA. Install the CA's certificate prior to installing subordinate certificates.	FLASH (plain text) and RAM (plain text)	1. Delete PKI domain from configuration via erase flash: command, write to startup config, then reboot. 2. Use "pki delete-certificate" CLI command to delete certificates, then reboot
CSP12	PRNG Seed Key	Entropy	Seed key for X9.31 PRNG	RAM (plain text)	Zeroized with generation of new seed

8.1 Access Control Policy

Table 5, Table 6, and Table 7 list by role services accessing CSPs. Each table identifies the services that access each CSP along with the type of access allowed for the role(s). The types of access are: read (r), write (w), and delete (d).

Table 5 CSP Access by Service for Visit and Monitor Roles

Service Access /CSP	View device status	Network functions	Security management
CSP1	R	r	r
CSP2	R	r	r
CSP3	R	r	r

Service Access /CSP	View device status	Network functions	Security management
CSP4	R	r	r
CSP5	R	r	r
CSP6	R	r	r
CSP7	R	r	r
CSP8	R	r	r
CSP9	R	r	r
CSP10	R	r	r
CSP11	R	r	r
CSP12	R	r	r

r = read, w = write, d = delete

Table 6 Access by Service for Config Role

Service Access /CSP	View device status	Network functions	Security management	Review the audit trail	View running status	Configure the security appliance
CSP1	R	r	rwd	r	r	r
CSP2	R	r	rwd	r	r	r
CSP3	R	r	rwd	r	r	r
CSP4	R	r	rwd	r	r	r
CSP5	R	r	rwd	r	r	r
CSP6	R	r	rwd	r	r	r
CSP7	R	r	rwd	r	r	r
CSP8	R	r	rwd	r	r	r
CSP9	R	r	r	r	r	r
CSP10	R	r	rwd	r	r	r
CSP11	R	r	rwd	r	r	r
CSP12	R	r	rwd	r	r	r

Table 7 Access by Service for Manage Role

Service Access /CSP	View device status	Network functions	Security management	Review the audit trail	View running status	Configure the security appliance
CSP1	R	r	rwd	r	r	r
CSP2	R	r	rwd	r	r	r
CSP3	R	r	rwd	r	r	r
CSP4	R	r	rwd	r	r	r
CSP5	R	r	rwd	r	r	r
CSP6	R	r	rwd	r	r	r
CSP7	R	r	rwd	r	r	r
CSP8	R	r	rwd	r	r	r
CSP9	R	r	rwd	r	r	r
CSP10	R	r	rwd	r	r	r
CSP11	R	r	rwd	r	r	r
CSP12	R	r	rwd	r	r	r

9 Self-Tests

HP Networking switches include an array of self-tests that are run during startup and during operations to prevent any secure data from being released and to insure all components are functioning correctly.

9.1 Power-On Self-Tests

The switches perform all power-on self-tests automatically at boot when FIPS mode is enabled. All power-on self-tests must be passed before any role can perform services. The power-on self-tests are performed prior to the initialization of the forwarding function, which prevents the security appliance from passing any data during a power-on self-test failure.

Table 8 HP Networking Switch Power-On Self-Tests

Implementation	Tests Performed
Security Appliance Software	Software/firmware Test
	DSA KAT (signature/verification)
	RSA KAT (signature/verification)
	RSA KAT (encrypt/decrypt)
	AES KAT
	Triple-DES KAT
	SHA-1 KAT
HMAC SHA-1 KAT	

Implementation	Tests Performed
	PRNG KAT

9.2 Conditional Self-Tests

Table 9 lists the conditional self-tests implemented by the switches. Conditional self tests run when a switch generates a DSA or RSA key pair and when it generates a random number.

Table 9 HP Networking Switch Conditional Self-Tests

Implementation	Tests Performed
Security Appliance Software	Pairwise consistency test for RSA
	Pairwise consistency test for DSA
	Continuous Random Number Generator Test for the FIPS-approved RNG (X9.31)

10 Delivery and Operation

10.1 Secure Delivery

To ensure no one has tampered with the goods during delivery, inspect the Networking switch physical package and check as follows:

- Outer Package Inspection
 - 1) Check that the outer carton is in good condition.
 - 2) Check the package for a HP Quality Seal or IPQC Seal, and ensure that it is intact.
 - 3) Check that the IPQC seal on the plastic bag inside the carton is intact.
 - 4) If any check failed, the goods shall be treated as dead-on-arrival (DOA) goods.
- Packing List Verification

Check against the packing list for discrepancy in material type and quantity. If any discrepancy found, the goods shall be treated as DOA goods.
- External Visual Inspection

Inspect the cabinet or chassis for any defects, loose connections, damages, and illegible marks. If any surface defect or material shortage found, the goods shall be treated as DOA goods.
- Confirm Software/firmware
 - 1) Version verification

To verify the software version, start the appliance, view the self test result during startup, and use the display version command to check that the software version is Comware software, Version 5.2, Release 1002(CC). 'FIPS1402&CC' indicate it is a FIPS 140-2 and CC certification version. If software loading failed or the version information is incorrect, please contact HP for support.
 - 2) SHA-256 verification

To verify that software/firmware has not been tampered, run SHA Hash command on the appliance. If the hash value is different from release notes of this software, contact HP for support. To get release notes, please access HP website:

- DOA (Dead on Arrival)

If the package is damaged, any label/seal is incorrect or tampered, stop unpacking the goods, retain the package, and report to HP for further investigation. The damaged goods will be replaced if necessary.

10.2 Secure Operation

The rules for securely operating an HP Networking switch in FIPS mode are:

- 1) Install and connect the device according to the installation and configuration guides.
- 2) Start the device, and enter the configuration interface.
- 3) Check and configure the clock.
- 4) By default, the device does not run in FIPS mode. Enable the device to work in FIPS mode using the **fips mode enable** command in system view. This will allow the switch to internally enforce FIPS-compliance behavior, such as run power-up self-test and conditional self-test.
- 5) Delete all MD5-based digital certificates.
- 6) Delete the DSA key pairs that have a modulus length of less than 1024 bits and all RSA key pairs.
- 7) Set up username/password for crypto officer role and user role. Each password must comprise no less than 6 characters and must contain uppercase and lowercase letters, digits, and special characters.
- 8) Save the configurations and re-start the device.
The device works in FIPS mode after restarting:
- 9) Configure the security appliance to use SSHv2.
- 10) Configure the security appliance to use HTTPS for performing system management.

An operator can determine whether a switch is in FIPS mode with the command **display fips status**. When in FIPS mode:

- The FTP/TFTP server is disabled.
- The Telnet server is disabled.
- The HTTP server is disabled.
- SNMP v1 and SNMP v2c are disabled. Only SNMP v3 is available.
- The SSL server only supports TLS1.0.
- The SSH server does not support SSHv1 clients
- Generated RSA/DSA key pairs have a modulus length from 1024 to 2048 bits.
- SSH, SNMPv3, IPSec and SSL do not support DES, RC4, or MD5.

11 Physical Security Mechanism

FIPS 140-2 Security Level 2 Physical Security requirements mandate that a cryptographic module have an opaque enclosure with tamper-evident seals for doors or removable covers. HP Networking switches include both appliance and chassis models. The tamper-evident seals and

opacity shields shall be installed for the module to operate in a FIPS Approved mode of operation. All Networking switches need tamper-evident seals to meet the Physical Security requirements. Some models also need opacity shields (7506-V, and 7510).

The Crypto Officer is responsible for properly placing all tamper evident labels on a switch and is responsible for the securing and control of any unused seals and opacity shields. The Crypto Officer shall clean the module of any grease, dirt, or oil before applying the tamper-evident labels or opacity shields. The Crypto Officer is also responsible for the direct control and observation of any changes to the modules such as reconfigurations where the tamper-evident labels or opacity shields are removed or installed to ensure the security of the module is maintained during such changes and the module is returned to a FIPS approved state. The security labels recommended for FIPS 140-2 compliance are provided in the FIPS Kit:

All units use the same label kits:

Label Kit – Description	Label Kit - Part Number
HP 12mm x 60mm Tamper-Evidence (30) Labels	JG585A
HP 12mm x 60mm Tamper-Evidence (100) Labels	JG586A

The opacity kit for each product model is below:

5120-EI series

Unit	Opacity Kit – Description	Opacity kit – Part Number
HP 5120-24G EI	HP 5500/5120 Gig-T EI Opacity Shield Kit	JG557A
HP 5120-48G EI	HP 5500/5120 Gig-T EI Opacity Shield Kit	JG557A
HP 5120-24G-PoE+ EI	HP 5500/5120 Gig-T PoE EI Opacity Shield Kit	JG559A
HP 5120-48G-PoE+ EI	HP 5500/5120 Gig-T PoE EI Opacity Shield Kit	JG559A

5500 EI series

Unit	Opacity Kit – Description	Opacity kit – Part Number
HP 5500-24G EI	HP 5500/5120 Gig-T EI Opacity Shield Kit	JG557A
HP 5500-24G-PoE+ EI	HP 5500/5120 Gig-T PoE EI Opacity Shield Kit	JG559A
HP 5500-24G-SFP EI	HP 5500-24G-SFP EI Opacity Shield Kit	JG558A
HP 5500-48G EI	HP 5500/5120 Gig-T EI Opacity Shield Kit	JG557A
HP 5500-48G-PoE+ EI	HP 5500/5120 Gig-T PoE EI Opacity Shield Kit	JG559A

5800 series

Unit	Opacity Kit – Description	Opacity kit – Part Number
HP 5800-24G	HP 5800-24G / -48G Opacity Shield Kit	JG563A
HP 5800-24G-PoE+	HP 5800-24G / -48G PoE Opacity Shield Kit	JG560A
HP 5800-24G-SFP	HP 5800-24G-SFP Opacity Shield Kit	JG562A
HP 5800-48G	HP 5800-24G / -48G Opacity Shield Kit	JG563A
HP 5800-48G-PoE	HP 5800-24G / -48G PoE Opacity Shield Kit	JG560A
HP 5800-48G -2slot	HP 58xx 2-slot Switch Opacity Shield Kit	JG561A

5820 series

Unit	Opacity Kit – Description	Opacity kit – Part Number
HP 5820-14XG-SFP	HP 58xx 2-slot Switch Opacity Shield Kit	JG561A
HP 5820-24XG-SFP	HP 5800-24XG-SFP+ Opacity Shield Kit	JG564A

7500 series

Unit	Opacity Kit – Description	Opacity kit – Part Number
HP 7510	HP 7510 Opacity Shield Kit	JG565A
HP 7506	HP 7506 Opacity Shield Kit	JG566A
HP 7506V	HP 7506-V Opacity Shield Kit	JG567A
HP 7503	HP 7503 Opacity Shield Kit	JG568A
HP 7502	HP 75xx 1-slot Switch Opacity Shield Kit	JG569A
HP 7503-S	HP 75xx 1-slot Switch Opacity Shield Kit	JG569A

9500 series

Unit	Opacity Kit – Description	Opacity kit – Part Number
HP 9505	HP 8805 Opacity Shield Kit	JG570A
HP 9508V	HP 8808 Opacity Shield Kit	JG571A
HP 9512	HP 8812 Opacity Shield Kit	JG572A

12500 series

Unit	Opacity Kit – Description	Opacity kit – Part Number
HP 12504	HP 12504 Opacity Shield Kit	JG721A
HP 12508	None – no opacity shield required	N/A
HP 12518	None – no opacity shield required	N/A

The customer can order either kit to provide the required number of labels for their installation needs.

These security labels are very fragile and cannot be removed without clear signs of damage to the labels.

Each modular switch is entirely encased by a thick steel chassis. Modular switches have one or two MPU slots and between two and eighteen slots for LPU. 12500 models have slots for switching fabric cards. On-board LAN connectors and console connectors are provided on the MPU board. Power cable connection and a power switch are provided on the power supplies. The individual modules that comprise the switch may be removed to allow access to the internal components of each module.

Any chassis slot that is not populated with a module must have a slot cover installed in order to operate in a FIPS compliant mode. The slot covers are included with each chassis, and additional slot covers may be ordered from HP.

Use the procedure described in the appropriate FIPS enclosure install instructions to apply tamper evident labels and opacity shields to the switch.

The Crypto Officer should inspect the tamper evident labels periodically to verify they are intact and the serial numbers on the applied tamper evident labels match the records in the security log.

12 Mitigation of Other Attacks

The Security appliances do not claim to mitigate any attacks in a FIPS approved mode of operation.

13 Documentation References

13.1 Obtaining documentation

You can access the HP Networking products page: <http://h17007.www1.hp.com/us/en/> , where you can obtain the up-to-date documents of HP Routers and Switches, such as datasheet, installation manual, configuration guide, command reference , and so on.

13.2 Technical support

For technical or sales related question please refer to the contacts list on the HP websit: <http://www.HP.com>.

The actual support website is:

<http://www8.hp.com/us/en/support-drivers.html>