

FIPS 140-2 Security Policy

FortiGate-200B/300C/310B/600C/620B

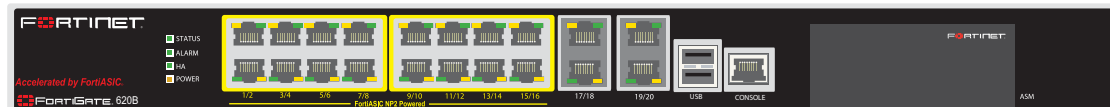
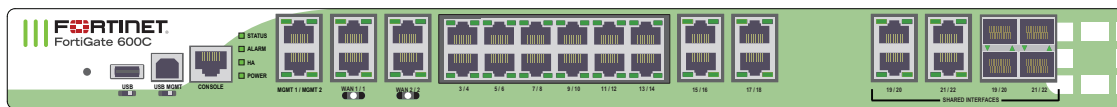
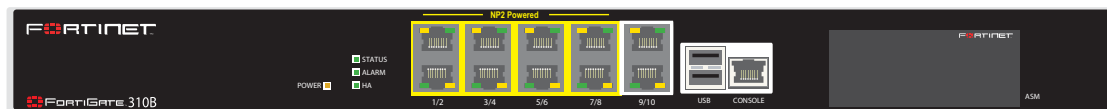
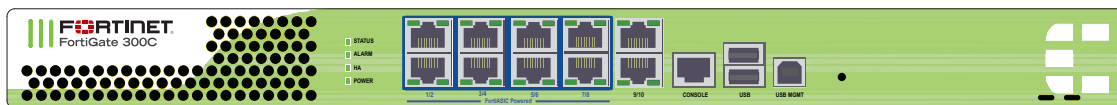
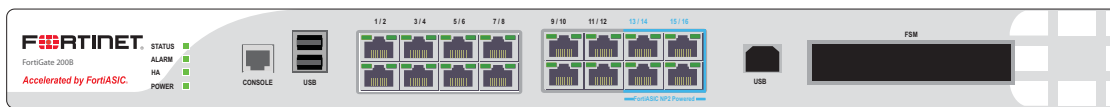

FortiGate-200B/300C/310B/600C/620B FIPS 140-2 Security Policy		
Document Version:	2.0	
Publication Date:	May 20, 2014	
Description:	Documents FIPS 140-2 Level 2 Security Policy issues, compliancy and requirements for FIPS compliant operation.	
Firmware Version:	FortiOS 4.0, build3830, 131223	
Hardware Version:	FortiGate-200B (C4CD24)	FortiGate-310B (C4ZF35)
	FortiGate-300C (C4HY50)	FortiGate-600C (C4HR40)
		FortiGate-620B(C4AK26)

FortiGate-200B/300C/310B/600C/620B: FIPS 140-2 Security Policy

01-436-176386-20120719

for FortiOS 4.0 MR3

© Copyright 2014 Fortinet, Inc.

This document may be freely reproduced and distributed whole and intact including this copyright notice.

Trademarks

Dynamic Threat Prevention System (DTPS), APSecure, FortiASIC, FortiBIOS, FortiBridge, FortiClient, FortiGate®, FortiGate Unified Threat Management System, FortiGuard®, FortiGuard-Antispam, FortiGuard-Antivirus, FortiGuard-Intrusion, FortiGuard-Web, FortiLog, FortiAnalyzer, FortiManager, Fortinet®, FortiOS, FortiPartner, FortiProtect, FortiReporter, FortiResponse, FortiShield, FortiVoIP, and FortiWiFi are trademarks of Fortinet, Inc. in the United States and/or other countries. The names of actual companies and products mentioned herein may be the trademarks of their respective owners.

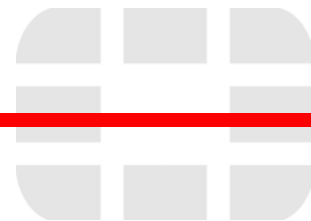

Contents

Overview	2
References	2
Introduction	2
Security Level Summary	3
Module Description	3
Cryptographic Module Ports and Interfaces	4
FortiGate-200B Module	4
FortiGate-300C Modules	6
FortiGate-310B Modules	7
FortiGate-600C Module	8
FortiGate-620B Module	9
Web-Based Manager	10
Command Line Interface	11
Roles, Services and Authentication	11
Roles	11
FIPS Approved Services	12
Authentication	13
Physical Security	14
Operational Environment	19
Cryptographic Key Management	19
Random Number Generation	19
Key Zeroization	20
Algorithms	21
Cryptographic Keys and Critical Security Parameters	21
Alternating Bypass Feature	23
Key Archiving	23
Electromagnetic Interference/Electromagnetic Compatibility (EMI/EMC)	24
Mitigation of Other Attacks	24
FIPS 140-2 Compliant Operation	25
Enabling FIPS-CC mode	26
Self-Tests	26
Non-FIPS Approved Services	27

Overview

This document is a FIPS 140-2 Security Policy for Fortinet Incorporated's FortiGate-200B, 300C, 310B, 600C and 620B Multi-Threat Security Systems. This policy describes how the FortiGate-200B, 300C, 310B, 600C and 620B (hereafter referred to as the 'modules') meet the FIPS 140-2 security requirements and how to operate the module in a FIPS compliant manner. This policy was created as part of the Level 2 FIPS 140-2 validation of the modules.

This document contains the following sections:

- [Introduction](#)
- [Security Level Summary](#)
- [Module Description](#)
- [Mitigation of Other Attacks](#)
- [FIPS 140-2 Compliant Operation](#)
- [Self-Tests](#)
- [Non-FIPS Approved Services](#)

The Federal Information Processing Standards Publication 140-2 - *Security Requirements for Cryptographic Modules* (FIPS 140-2) details the United States Federal Government requirements for cryptographic modules. Detailed information about the FIPS 140-2 standard and validation program is available on the NIST (National Institute of Standards and Technology) website at <http://csrc.nist.gov/groups/STM/cmvp/index.html>.

References

This policy deals specifically with operation and implementation of the module in the technical terms of the FIPS 140-2 standard and the associated validation program. Other Fortinet product manuals, guides and technical notes can be found at the Fortinet technical documentation website at <http://docs.forticare.com>.

Additional information on the entire Fortinet product line can be obtained from the following sources:

- Find general product information in the product section of the Fortinet corporate website at <http://www.fortinet.com/products>.
- Find on-line product support for registered products in the technical support section of the Fortinet corporate website at <http://www.fortinet.com/support>
- Find contact information for technical or sales related questions in the contacts section of the Fortinet corporate website at <http://www.fortinet.com/contact>.
- Find security information and bulletins in the FortiGuard Center of the Fortinet corporate website at <http://www.fortinet.com/FortiGuardCenter>.

Introduction

The FortiGate product family spans the full range of network environments, from SOHO to service provider, offering cost effective systems for any size of application. FortiGate appliances detect and eliminate the most damaging, content-based threats from email and Web traffic such as viruses, worms, intrusions, inappropriate Web content and more in real time — without degrading network performance. In addition to providing application level firewall protection, FortiGate appliances deliver a full range of network-level services — VPN, intrusion prevention, web filtering, antivirus, antispam and traffic shaping — in dedicated, easily managed platforms.

All FortiGate appliances employ Fortinet's unique FortiASIC™ content processing chip and the powerful, secure, FortiOS™ firmware achieve breakthrough price/performance. The unique, ASIC-based architecture analyzes content and behavior in real time, enabling key applications to be deployed right at the network edge where they are most effective at protecting enterprise networks. They can be easily configured to provide antivirus protection, antispam protection and content filtering in conjunction with existing firewall, VPN, and related devices, or as complete network protection systems. The modules support High Availability (HA) in both Active-Active (AA) and Active-Passive (AP) configurations.

FortiGate appliances support the IPSec industry standard for VPN, allowing VPNs to be configured between a FortiGate appliance and any client or gateway/firewall that supports IPSec VPN. FortiGate appliances also provide SSL VPN services using TLS 1.0 in the FIPS-CC mode of operation.

Security Level Summary

The modules meet the overall requirements for a FIPS 140-2 Level 2 validation.

Table 1: Summary of FIPS security requirements and compliance levels

Security Requirement	Compliance Level
Cryptographic Module Specification	2
Cryptographic Module Ports and Interfaces	3
Roles, Services and Authentication	3
Finite State Model	2
Physical Security	2
Operational Environment	2
Cryptographic Key Management	2
EMI/EMC	2
Self-Tests	2
Design Assurance	3
Mitigation of Other Attacks	2

Module Description

FortiGate-200B, 300C, 310B, 600C and 620B are multiple chip, standalone cryptographic modules consisting of production grade components contained in a physically protected enclosure in accordance with FIPS 140-2 Level 2 requirements.

- The FortiGate-200B has 16 network interfaces with a status LED for each network interface (8x 10/100 BaseT, 8x 10/100/1000 Base T)
- The FortiGate-300C and 310B have 10 network interfaces with a status LED for each network interface (10x 10/100/1000 BaseT)
- The FortiGate-600C has 30 network interfaces with a status LED for each network interface (8x shared interfaces (1GB SFP or 10/100/1000 Base-T), 22x 10/100/1000 Base-T)
- The FortiGate-620B has 20 network interfaces with a status LED for each network interface (20x 10/100/1000 BaseT)

The FortiGate-600C and 620B module have a single, dual core, x86 compatible CPU. The other modules have a single, x86 compatible CPU.

The modules are 1u rackmount devices.

The FortiGate-300C module has 4 external ventilation fans on the back panel of the chassis.

The FortiGate-310B module has 3 external ventilation fans on the back panel of the chassis.

The FortiGate-600C and 620B have 5 external ventilation fans on the back panel of the chassis.

The FortiGate-600C module has 8 shared network interfaces that support a 1GB SFP or 10/100/1000Base-T connection. Only one of the shared interface pair can be used at any given time. The FortiGate-600C module also has 4 paired Bypass interfaces (WAN1/Port1 and WAN2/Port2). If bypass is enabled, these interfaces provide a physical bypass of the paired port if the module fails, hangs or power is lost. The bypass capability is only available if the module is configured for Transparent operation, not NAT operation. Use of the bypass capability is a non-FIPS approved service.

The FortiGate-200B has 1 Fortinet FSM slot and one SSD drive is installed by default.

The FortiGate-310B and 620B modules support Advanced Mezzanine Card (AMC) components. The AMC components can provide hard disk support or additional input/output interfaces. The FortiGate-310B and 620B modules have 1 slot for a single-width, full size, AMC component. Use of AMC components is optional. The models were tested with an AMC hard disk component installed.

The FortiGate-600C module has 1, internal, 64GB SSD drive.

The validated firmware version is FortiOS 4.0, build3830, 131223.

Figure 1, Figure 2, Figure 3, Figure 4 and Figure 5 are representative of the modules tested.

Cryptographic Module Ports and Interfaces

FortiGate-200B Module

Figure 1: FortiGate-200B Front and Rear Panels

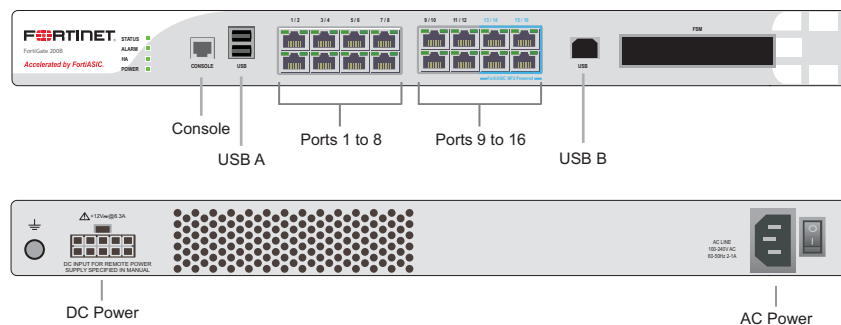

Table 2: FortiGate-200B Status LEDs

LED		State	Description
Power		Green	The module is powered on.
		Off	The module is powered off.
Status		Flashing Green	The module is starting up.
		Green	The module is running normally.
HA		Green	The module is part of an HA cluster.
Alarm		Red	A critical error has occurred.
		Amber	A minor error has occurred.
		Off	No errors detected.
Ports 1 to 8	Link	Green	Port is online.
		Off	Port is offline.
	Speed	Amber	Connected at 100 Mbps.
		Off	Connected at 10Mbps.
Ports 9 to 16	Link	Green	Port is online.
		Green blinking	Port is receiving or sending data.
	Speed	Green	Connected at 1000 Mbps.
		Amber	Connected at 100 Mbps.
		Off	Connected at 10Mbps.

Table 3: FortiGate-200B Connectors and Ports

Connector	Type	Speed	Supported Logical Interfaces	Description
Ports 1 to 8	RJ-45	10/100 Base_T	Data input, data output, control input and status output	Connection to 10/100 networks.
Ports 9 to 16	RJ-45	10/100/1000 Base-T	Data input, data output, control input and status output	Connection to 10/100/1000 networks.
Console Port	RJ-45	9600 bps	Control input, status output	Optional connection to the management computer. Provides access to the command line interface (CLI).
USB A Ports	USB	N/A	Key loading and archiving	Optional USB token.
USB B Port	USB	N/A	N/A	Future use.
AC POWER	N/A	N/A	Power	120/240VAC power connection.
DC POWER	N/A	N/A	Power	+12VDC power connection.

FortiGate-300C Modules

Figure 2: FortiGate-300C Front and Rear Panels

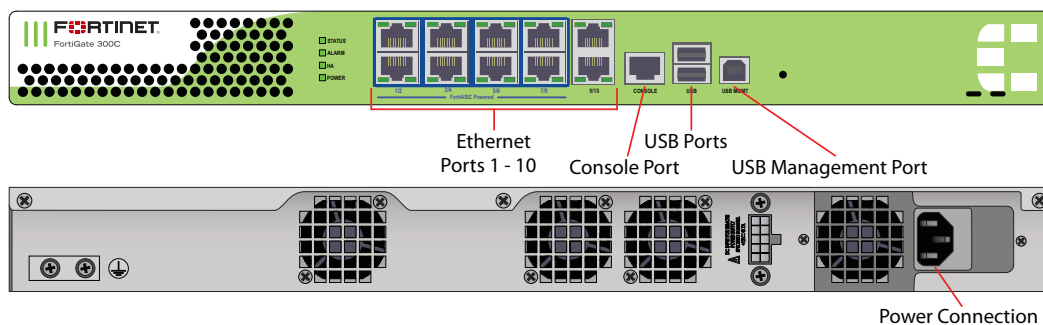

Table 4: FortiGate-300C Status LEDs

LED	State	Description	
Power	Green	The module is powered on.	
	Off	The module is powered off.	
Status	Flashing Green	The module is starting up.	
	Green	The module is running normally.	
HA	Green	HA is enabled.	
	Red	The module is in failover mode.	
	Off	The unit is in stand-alone mode.	
Alarm	Red	The module is indicating a major fault.	
	Amber	The module is indicating a minor fault.	
	Off	The module is operating normally.	
Ports 1 to 10	Link	Green	Port is online.
		Green blinking	Port is receiving or sending data.
	Speed	Green	Connected at 1000 Mbps.
		Amber	Connected at 100 Mbps.
		Off	Connected at 10Mbps.

Table 5: FortiGate-300C Connectors and Ports

Connector	Type	Speed	Supported Logical Interfaces	Description
Ports 1 to 10	RJ-45	10/100/1000 Base-T	Data input, data output, control input and status output	Connection to 10/100/1000 networks.
Console Port	RJ-45	9600 bps	Control input, status output	Optional connection to the management computer. Provides access to the command line interface (CLI).
USB Ports	USB	N/A	Key loading and archiving, configuration backup and restore	Optional USB token.

Table 5: FortiGate-300C Connectors and Ports

USB MGMT	USB	N/A	Control input, status output	Optional connection for management/configuration using FortiExplorer.
AC POWER	N/A	N/A	Power	120/240VAC power connection.

FortiGate-310B Modules

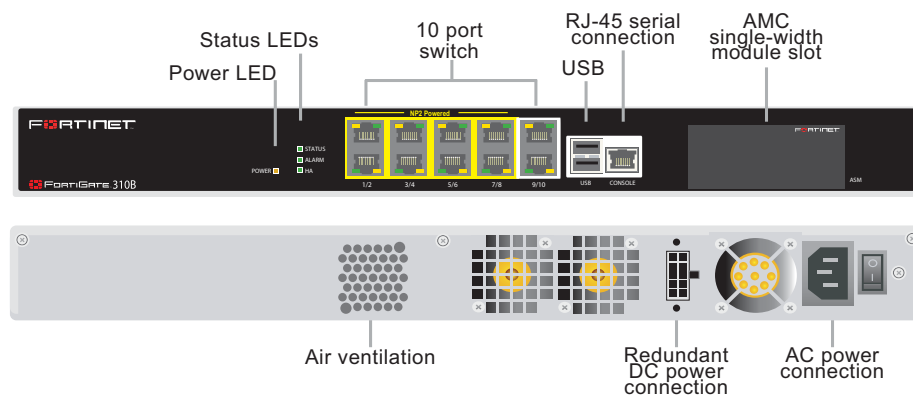
Figure 3: FortiGate-310B Front and Rear Panels**Table 6: FortiGate-310B Status LEDs**

LED	State	Description	
Power	Green	The module is powered on.	
	Off	The module is powered off.	
Status	Flashing Green	The module is starting up.	
	Green	The module is running normally.	
HA	Green	The module is part of an HA cluster.	
Alarm	N/A	Future use.	
Ports 1 to 10	Link	Green	Port is online.
		Green blinking	Port is receiving or sending data.
	Speed	Green	Connected at 1000 Mbps.
		Amber	Connected at 100 Mbps.
		Off	Connected at 10Mbps.

Table 7: FortiGate-310B Connectors and Ports

Connector	Type	Speed	Supported Logical Interfaces	Description
Ports 1 to 10	RJ-45	10/100/1000 Base-T	Data input, data output, control input and status output	Connection to 10/100/1000 networks.
Console Port	RJ-45	9600 bps	Control input, status output	Optional connection to the management computer. Provides access to the command line interface (CLI).

Table 7: FortiGate-310B Connectors and Ports

USB Ports	USB	N/A	Key loading and archiving	Optional USB token.
AC POWER	N/A	N/A	Power	120/240VAC power connection.

FortiGate-600C Module

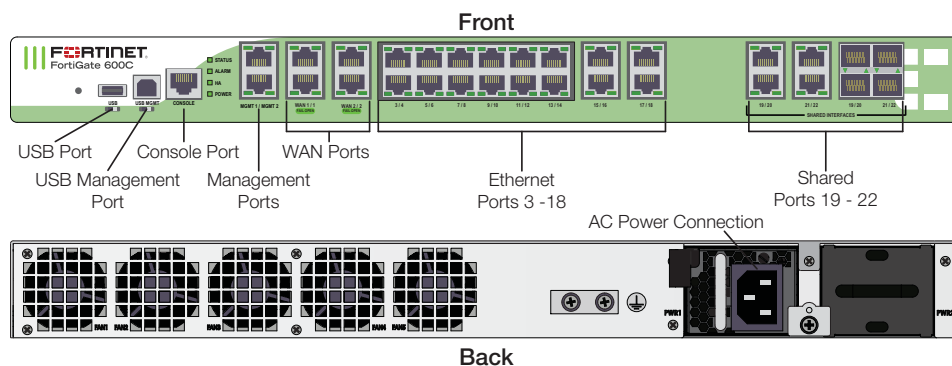
Figure 4: FortiGate-600C Front and Rear Panels**Table 8: FortiGate-600C Status LEDs**

LED		State	Description
Power		Green	The module is powered on.
		Off	The module is powered off.
Status		Flashing Green	The module is starting up.
		Green	The module is running normally.
HA		Green	HA is enabled.
		Red	The module is in failover mode.
		Off	The unit is in stand-alone mode.
Alarm		Red	The module is indicating a major fault.
		Amber	The module is indicating a minor fault.
		Off	The module is operating normally.
MGMT1 and MGMT2, Ports 1 to 22 (Ethernet)	Link	Green	Port is online.
		Green blinking	Port is receiving or sending data.
	Speed	Green	Connected at 1000 Mbps.
		Amber	Connected at 100 Mbps.
Off		Connected at 10Mbps.	
Ports 19-22 (SFP)		Green	Port is online.
		Flashing	Port is receiving or sending data.

Table 9: FortiGate-600C Connectors and Ports

Connector	Type	Speed	Supported Logical Interfaces	Description
MGMT Ports, WAN Ports, Ports 1 to 22	RJ-45	10/100/1000 Base-T	Data input, data output, control input and status output	Connection to 10/100/1000 networks.
Ports 19-22	SFP	1 Gbps	Data input, data output, control input and status output	
Console Port	RJ-45	9600 bps	Control input, status output	Optional connection to the management computer. Provides access to the command line interface (CLI).
USB Ports	USB	N/A	Key loading and archiving	Optional USB token.
USB MGMT	USB	N/A	Control input, status output	Optional connection for management/configuration using FortiExplorer.
AC POWER	N/A	N/A	Power	120/240VAC power connection.

FortiGate-620B Module

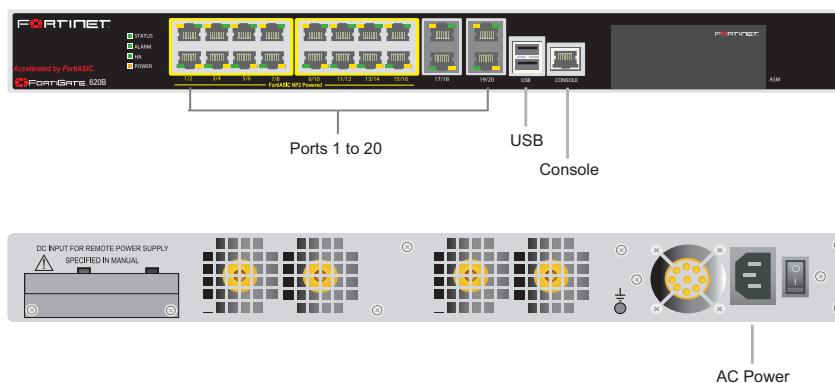
Figure 5: FortiGate-620B Front and Rear Panels**Table 10: FortiGate-620B Status LEDs**

LED	State	Description
Power	Green	The module is powered on.
	Off	The module is powered off.
Status	Flashing Green	The module is starting up.
	Green	The module is running normally.
HA	Green	The module is part of an HA cluster.
Alarm	N/A	Future use.

Table 10: FortiGate-620B Status LEDs

Ports 1 to 20	Link	Green	Port is online.
		Green blinking	Port is receiving or sending data.
	Speed	Green	Connected at 1000 Mbps.
		Amber	Connected at 100 Mbps.
		Off	Connected at 10Mbps.

Table 11: FortiGate-620B Connectors and Ports

Connector	Type	Speed	Supported Logical Interfaces	Description
Ports 1 to 20	RJ-45	10/100/1000 Base-T	Data input, data output, control input and status output	Connection to 10/100/1000 networks.
Console Port	RJ-45	9600 bps	Control input, status output	Optional connection to the management computer. Provides access to the command line interface (CLI).
USB Ports	USB	N/A	Key loading and archiving	Optional USB token.
AC POWER	N/A	N/A	Power	120/240VAC power connection.

Web-Based Manager

The FortiGate web-based manager provides GUI based access to the module and is the primary tool for configuring the module. The manager requires a web browser on the management computer and an Ethernet connection between the FortiGate unit and the management computer.

A web-browser that supports Transport Layer Security (TLS) 1.0 is required for remote access to the web-based manager when the module is operating in FIPS-CC mode. HTTP access to the web-based manager is not allowed in FIPS-CC mode and is disabled.

Figure 6: The FortiGate web-based manager

Command Line Interface

The FortiGate Command Line Interface (CLI) is a full-featured, text based management tool for the module. The CLI provides access to all of the possible services and configuration options in the module. The CLI uses a console connection or a network (Ethernet) connection between the FortiGate unit and the management computer. The console connection is a direct serial connection. Terminal emulation software is required on the management computer using either method. For network access, a Telnet or SSH client that supports the SSH v2.0 protocol is required (SSH v1.0 is not supported in FIPS-CC mode). Telnet access to the CLI is not allowed in FIPS-CC mode and is disabled.

Roles, Services and Authentication

Roles

When configured in FIPS-CC mode, the module provides the following roles:

- Crypto Officer
- Network User

The Crypto Officer role is initially assigned to the default 'admin' operator account. The Crypto Officer role has read-write access to all of the module's administrative services. The initial Crypto Officer can create additional operator accounts. These additional accounts are assigned the Crypto Officer role and can be assigned a range of read/write or read only access permissions including the ability to create operator accounts.

The module provides a **Network User** role for end-users (Users). Network users can make use of the encrypt/decrypt services, but cannot access the module for administrative purposes.

The module does not provide a Maintenance role.

FIPS Approved Services

The following tables detail the types of FIPS approved services available to each role, the types of access for each role and the Keys or CSPs they affect.

The role names are abbreviated as follows:

Crypto Officer CO
User U

The access types are abbreviated as follows:

Read Access R
Write Access W
Execute Access E

Table 12: Services available to Crypto Officers

Service	Access	Key/CSP
authenticate to module	WE	Operator Password, Diffie-Hellman Key, HTTP/TLS and SSH Server/Host Keys, HTTPS/TLS and SSH Session Authentication Keys, and HTTPS/TLS Session Encryption Keys, RNG Seed, RNG AES Key
show system status	WE	N/A
show FIPS-CC mode enabled/disabled (console/CLI only)	WE	N/A
enable FIPS-CC mode of operation (console only)	WE	Configuration Integrity Key
execute factory reset (zeroize keys, disable FIPS mode, console/CLI only)	E	See "Key Zeroization" on page 20
execute FIPS-CC on-demand self-tests (console only)	E	Configuration Integrity Key, Firmware Integrity Key
add/delete operators and network users	WE	Operator Password, Network User Password
set/reset operator and network user passwords	WE	Operator Password, Network User Password
backup configuration file	WE	Configuration Encryption Key, Configuration Backup Key
read/set/delete/modify module configuration	WE	N/A
enable/disable alternating bypass mode	WE	N/A

Table 12: Services available to Crypto Officers

Service	Access	Key/CSP
read/set/delete/modify IPsec/SSL VPN configuration	N/A	IPsec: IPsec Manual Authentication Key, IPsec Manual Encryption Key, IKE Pre-Shared Key, IKE RSA Key SSL: HTTPS/TLS Server/Host Key, HTTPS/TLS Session Authentication Key, HTTPS/TLS SSH Session Encryption Key
read/set/delete/modify HA configuration	WE	HA Password, HA Encryption Key
execute firmware update	E	Firmware Update Key
read log data	WE	N/A
delete log data (console/CLI only)	N/A	N/A
execute system diagnostics (console/CLI only)	WE	N/A

Table 13: Services available to Network Users

Service/CSP	Access	Key/CSP
authenticate to module	E	Network User Password, Diffie-Hellman Key, HTTPS/TLS Server/Host Key, HTTPS/TLS Session Authentication Key, HTTPS/TLS Session Encryption Key, RNG Seed, RNG AES Key
IPsec VPN controlled by firewall policies	E	Diffie-Hellman Key, IKE and IPsec Keys, RNG Seed, RNG AES Key
SSL VPN controlled by firewall policies	E	Network User Password, Diffie-Hellman Key, HTTPS/TLS Server/Host Key, HTTPS/TLS Session Authentication Key, HTTPS/TLS Session Encryption Key, RNG Seed, RNG AES Key

Authentication

The modules implement identity based authentication. Operators must authenticate with a user-id and password combination to access the modules remotely or locally via the console. Remote operator authentication is done over HTTPS (TLS) or SSH. Password entry is obfuscated using asterisks and the module does not provide feedback on the authentication process - i.e. the module does not indicate if the password or the user/operator account is incorrect for a failed authentication attempt.

By default, Network User access to the modules is based on firewall policy and authentication by IP address or fully qualified domain names. Network Users can optionally be forced to authenticate to the modules using a username/password combination to enable use of the IPsec VPN encrypt/decrypt or bypass services. For Network Users invoking the SSL-VPN encrypt/decrypt services, the modules support authentication with a user-id/password combination. Network User authentication is done over HTTPS and does not allow access to the modules for administrative purposes.

Note that operator authentication over HTTPS/SSH and Network User authentication over HTTPS are subject to a limit of 3 failed authentication attempts in 1 minute. Operator authentication using the console is not subject to a failed authentication limit, but the number of authentication attempts per minute is limited by the bandwidth available over the serial connection.

The minimum password length is 8 characters when in FIPS-CC mode (maximum password length is 32 characters). The password may contain any combination of upper- and lower-case letters, numbers, and printable symbols; allowing for 94 possible characters. The odds of guessing a password are 1 in 94^8 which is significantly lower than one in a million. Recommended procedures to increase the password strength are explained in [“FIPS 140-2 Compliant Operation” on page 25](#).

For Network Users invoking the IPSec VPN encrypt/decrypt services, the module acts on behalf of the Network User and negotiates a VPN connection with a remote module. The strength of authentication for IPSec services is based on the authentication method defined in the specific firewall policy: IPSec manual authentication key, IKE pre-shared key or IKE RSA key (RSA certificate). The odds of guessing the authentication key for each IPSec method is:

- 1 in 16^{40} for the IPSec Manual Authentication key (based on a 40 digit, hexadecimal key)
- 1 in 94^8 for the IKE Pre-shared Key (based on an 8 character, ASCII printable key)
- 1 in 2^{1024} for the IKE RSA Key (based on a 1024bit RSA key size)

Therefore the minimum odds of guessing the authentication key for IPSec is 1 in 94^8 , based on the IKE Pre-shared key.

Physical Security

The modules meet FIPS 140-2 Security Level 2 requirements by using production grade components and an opaque, sealed enclosure. Access to the enclosure is restricted through the use of tamper-evident seals to secure the overall enclosure.

The seals are blue wax/plastic with white lettering that reads “Fortinet Inc. Security Seal”.

The tamper seals are not applied at the factory prior to shipping. It is the responsibility of the Crypto Officer to apply the seals before use to ensure full FIPS 140-2 compliance. Once the seals have been applied, the Crypto Officer must develop an inspection schedule to verify that the external enclosure of the module and the tamper seals have not been damaged or tampered with in any way. The Crypto Officer is also responsible for securing and controlling any unused seals.

The surfaces should be cleaned with 99% Isopropyl alcohol to remove dirt and oil before applying the seals. Ensure the surface is completely clean and dry before applying the seals. If a seal needs to be re-applied, completely remove the old seal and clean the surface with an adhesive remover before following the instructions for applying a new seal.

Additional seals can be requested through your Fortinet sales contact. Reference the following SKUs when ordering: FIPS-SEAL-RED or FIPS-SEAL-BLUE. Specify the type and number of seals required based on the specific module as described below:

The FortiGate-200B uses 2 blue seals to secure:

- the external enclosure (2 seals, see [Figure 7](#) and [Figure 8](#))

The FortiGate-300C uses 2 red seals to secure:

- the external enclosure (2 seals, see [Figure 9](#) and [Figure 10](#))

The FortiGate-310B use 2seals to secure:

- the external enclosure (one seal, see [Figure 11](#))
- the blank faceplate covering the AMC slot (one seal, see [Figure 12](#))

The FortiGate-600C uses 3 red seals to secure:

- the external enclosure, the power supply and the blank faceplate for the redundant power supply (see [Figure 13](#))

The FortiGate-620B uses 3 blue seals to secure:

- the external enclosure (2 seals, see [Figure 14](#) and [Figure 15](#))
- the blank faceplate covering the AMC slot (one seal, see [Figure 16](#))

Figure 7: FortiGate-200B external enclosure seal, bottom, left side

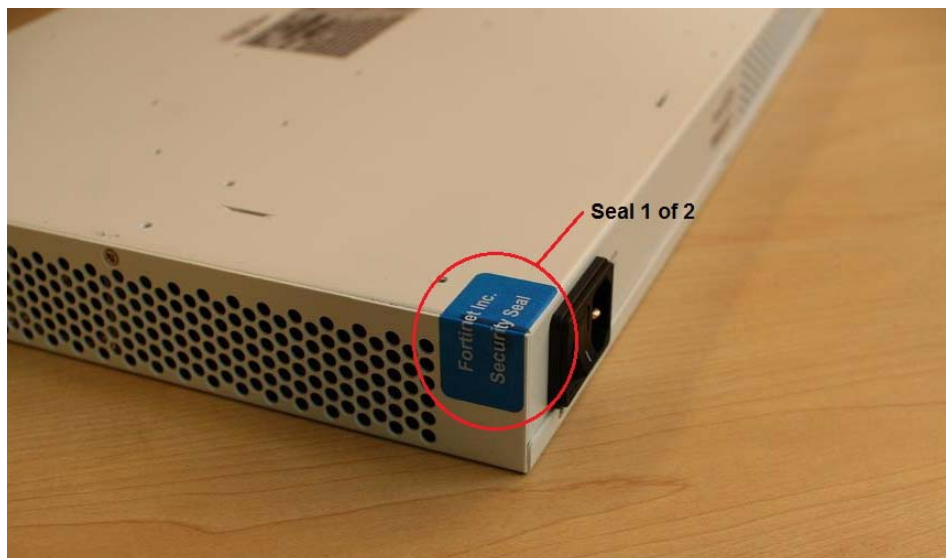

Figure 8: FortiGate-200B external enclosure seal, bottom, right side

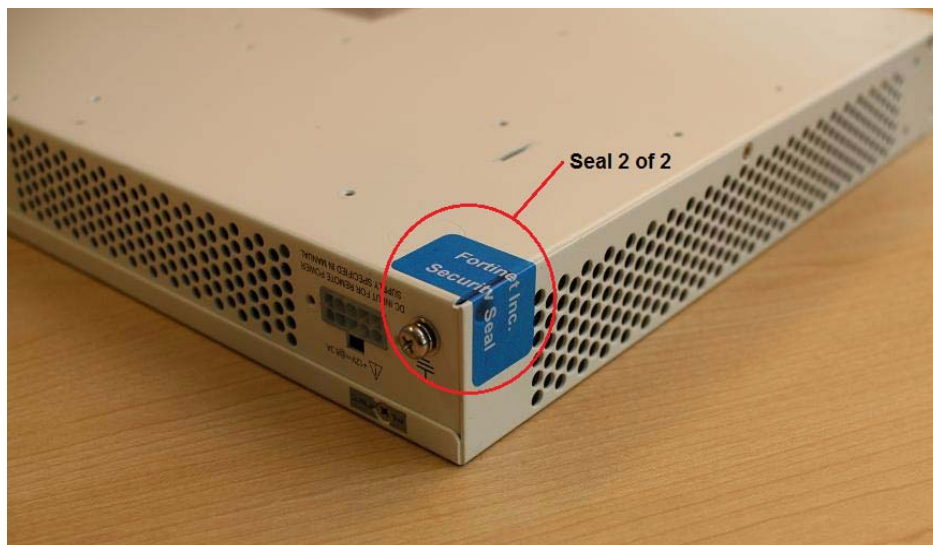

Figure 9: FortiGate-300C external enclosure seal, top, left side

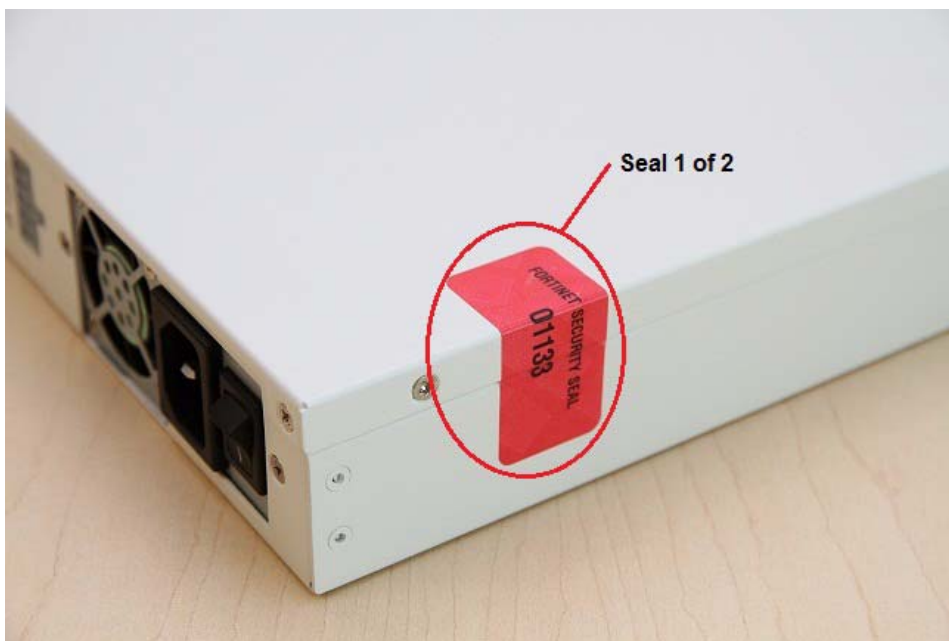

Figure 10: FortiGate-300C external enclosure seal, top, right side



Figure 11: FortiGate-310B external enclosure seal, top, left side

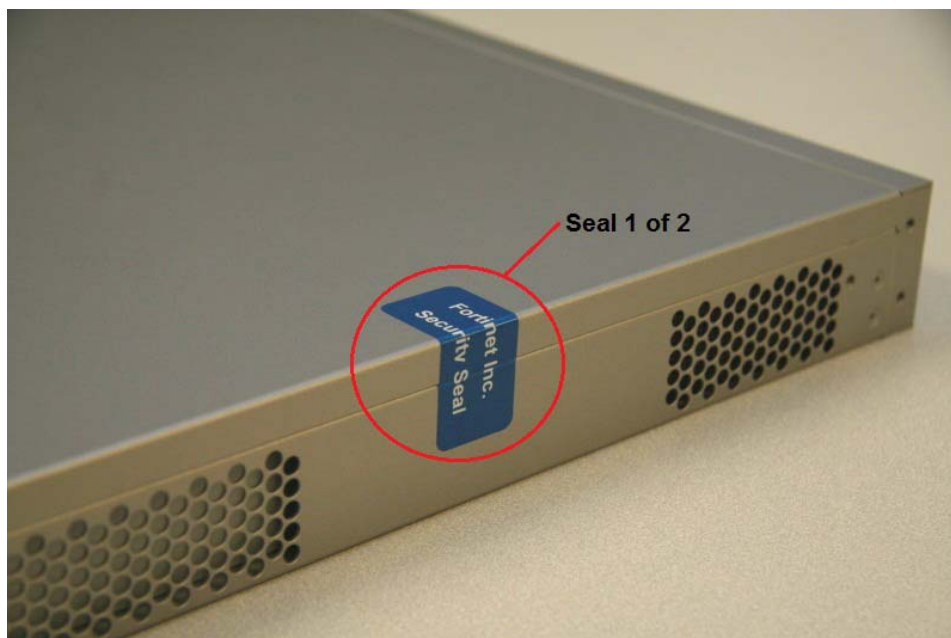

Figure 12: FortiGate-310B AMC faceplate seal, front



Figure 13: FortiGate-600C seals, bottom, rear

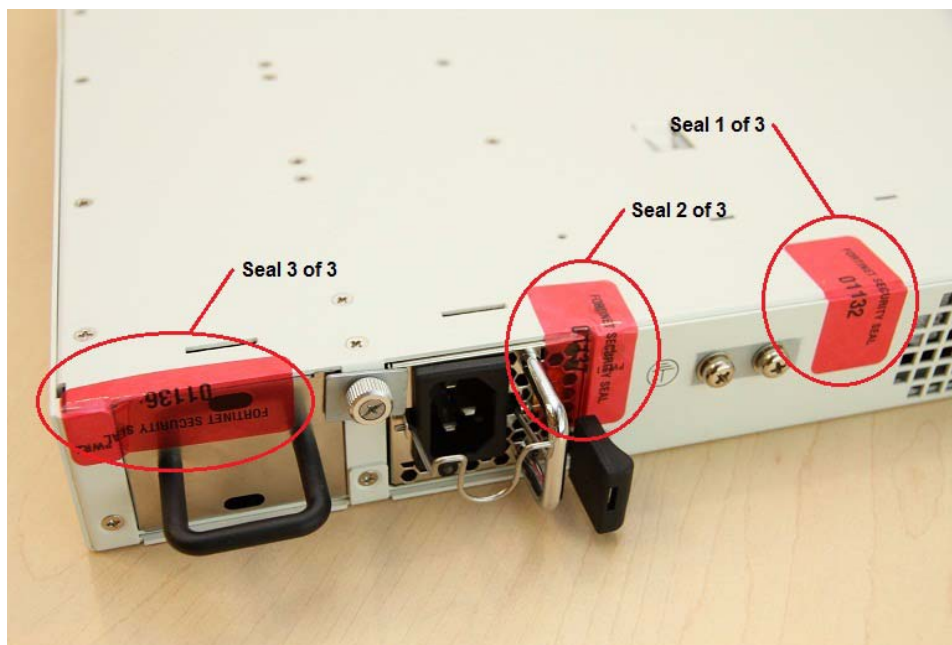

Figure 14: FortiGate-620B external enclosure seal, bottom, left side

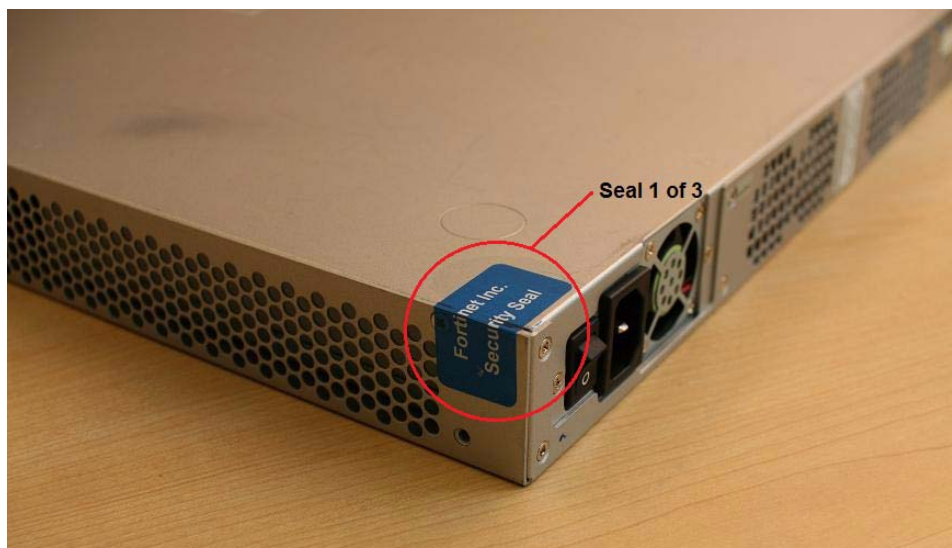
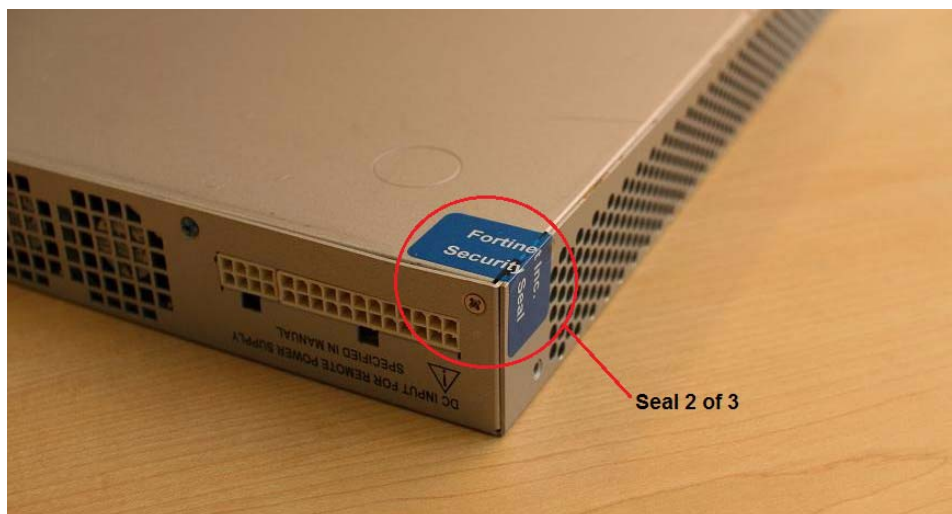

Figure 15: FortiGate-620B external enclosure seal, bottom, right side**Figure 16: FortiGate-620B AMC faceplate seal, front**

Operational Environment

The module consists of the combination of the FortiOS operating system and the FortiGate appliances. The FortiOS operating system can only be installed, and run, on a FortiGate appliance. The FortiOS operating system provides a proprietary and non-modifiable operating system.

Cryptographic Key Management

Random Number Generation

The modules use a firmware based, deterministic random number generator that conforms to ANSI X9.31 Appendix A.2.4.

The ANSI X9.31 RNG is seeded using a 128-bit AES seed key generated external to the module (estimated entropy 128 bits) and 256 bits of seed (estimated entropy 60 bits) gathered from a random pool filled with 64 bytes of system data and internal resources such as time, memory addresses, kernel ticks, and module identifiers. As the module's ANSI X9.31 RNG implementation only generates random values of size 128 bits, it would take multiple calls to form a 256-bit key. Each time a key is generated with a bit length of more than 128 bits, the key is refreshed with an additional 12 bits of entropy. The total estimated strength for the two calls required to form a 256 bit key would be at theoretical best 200 bits.

Key Zeroization

The zeroization process must be performed under the direct control of the operator. The operator must be present to observe that the zeroization method has completed successfully.

All keys except the following are zeroized by executing a factory reset:

- ANSI X9.31 RNG AES Key
- Firmware Update Key
- Firmware Integrity Key
- Configuration Integrity Key
- Configuration Backup Key
- SSH Server/Host Key
- HTTPS/TLS Server/Host Key

All keys and CSPs are zeroized by formatting the modules' flash memory storage. To format the flash memory, connect a computer to the modules' console port and reboot the module. Access the configuration menu by pressing any key when prompted (see example below). Select "F" to format the flash memory (boot device).

```
Press any key to display configuration menu...
```

```
[G]: Get firmware image from TFTP server.  
[F]: Format boot device.  
[B]: Boot with backup firmware and set as default.  
[I]: Configuration and information.  
[Q]: Quit menu and continue to boot with default firmware.  
[H]: Display this list of options.
```

```
Enter G,F,B,I,Q, or H:
```

Algorithms

Table 14: FIPS Approved Algorithms

Algorithm	NIST Certificate Number
RNG (ANSI X9.31 Appendix A)	1234
Triple-DES	1424, 1426, 1572, 1573
AES	2277, 2279, 2607, 2608
SHA-1	1958, 1960, 2191, 2192
SHA-256	1958, 1960, 2191, 2192
HMAC SHA-1	1395, 1397, 1615, 1616
HMAC SHA-256	1395, 1397, 1615, 1616
RSA PKCS1 (digital signature creation and verification)	1168, 1170, 1334

Table 15: FIPS Allowed Algorithms

Algorithm
RSA (key establishment methodology provides 80 or 112 bits of encryption strength)
Diffie-Hellman (key agreement; key establishment methodology provides between 80 and 201bits of encryption strength; non-compliant less than 80-bits of encryption strength)
NDRNG

Table 16: Non-FIPS Approved Algorithms

Algorithm
DES (disabled in FIPS-CC mode)
MD5 (disabled in FIPS-CC mode except for use in the TLS protocol)
HMAC MD5 (disabled in FIPS-CC mode)

Some algorithms may be classified as deprecated, restricted, or legacy-use. Please consult NIST SP 800-131A for details.

The vendor makes no conformance claims to any key derivation function specified in SP 800-135rev1. References to the key derivation functions addressed in SP 800-135rev1 including IKE, SSH, and TLS are only listed to clarify the key types supported by the module. Keys related to IKE, SSH, and TLS are only used in the Approved mode under the general umbrella of a non-Approved Diffie-Hellman scheme, with no assurance claims to the underlying key derivation functions.

Cryptographic Keys and Critical Security Parameters

The following table lists all of the cryptographic keys and critical security parameters used by the module. The following definitions apply to the table:

Key or CSP	The key or CSP description.
Storage	Where and how the keys are stored
Usage	How the keys are used

Table 17: Cryptographic Keys and Critical Parameters used in FIPS-CC Mode

Key or CSP	Storage	Usage
Diffie-Hellman Keys	SDRAM Plaintext	Key agreement and key establishment
IPSec Manual Authentication Key	Flash RAM AES encrypted	Used as IPSec Session Authentication Key
IPSec Manual Encryption Key	Flash RAM AES encrypted	Used as IPSec Session Encryption Key
IPSec Session Authentication Key	SDRAM Plain-text	IPSec peer-to-peer authentication using HMAC SHA-1
IPSec Session Encryption Key	SDRAM Plain-text	VPN traffic encryption/decryption using Triple-DES or AES
IKE Pre-Shared Key	Flash RAM AES encrypted	Used to generate IKE protocol keys
IKE Authentication Key	SDRAM Plain-text	IKE peer-to-peer authentication using HMAC SHA-1 (SKEYID_A)
IKE Key Generation Key	SDRAM Plain-text	IPSec SA keying material (SKEYID_D)
IKE Session Encryption Key	SDRAM Plain-text	Encryption of IKE peer-to-peer key negotiation using Triple-DES or AES (SKEYID_E)
IKE RSA Key	Flash Ram Plain text	Used to generate IKE protocol keys
RNG Seed (ANSI X9.31 Appendix A.2.4)	Flash RAM Plain-text	Seed used for initializing the RNG
RNG AES Key (ANSI X9.31 Appendix A.2.4)	Flash RAM Plain-text	AES Seed key used with the RNG
Firmware Update Key	Flash RAM Plain-text	Verification of firmware integrity when updating to new firmware versions using RSA public key
Firmware Integrity Key	Flash RAM Plain-text	Verification of firmware integrity in the firmware integrity test using RSA public key
HTTPS/TLS Server/Host Key	Flash RAM Plain-text	RSA private key used in the HTTPS/TLS protocols
HTTPS/TLS Session Authentication Key	SDRAM Plain-text	HMAC SHA-1 key used for HTTPS/TLS session authentication
HTTPS/TLS Session Encryption Key	SDRAM Plain-text	AES or Triple-DES key used for HTTPS/TLS session encryption
SSH Server/Host Key	Flash RAM Plain-text	RSA private key used in the SSH protocol
SSH Session Authentication Key	SDRAM Plain-text	HMAC SHA-1 key used for SSH session authentication
SSH Session Encryption Key	SDRAM Plain-text	AES or Triple-DES key used for SSH session encryption
Operator Password	Flash RAM SHA-1 hash	Used to authenticate operator access to the module
Configuration Integrity Key	Flash RAM Plain-text	SHA-1 hash used for configuration/VPN bypass test

Table 17: Cryptographic Keys and Critical Parameters used in FIPS-CC Mode

Key or CSP	Storage	Usage
Configuration Encryption Key	Flash RAM Plain-text	AES key used to encrypt CSPs on the flash RAM and in the backup configuration file (except for operator passwords in the backup configuration file)
Configuration Backup Key	Flash RAM Plain-text	HMAC SHA-1 key used to encrypt operator passwords in the backup configuration file
Network User Password	Flash RAM AES encrypted	Used during network user authentication
HA Password	Flash RAM AES encrypted	Used to authenticate FortiGate units in an HA cluster
HA Encryption Key	Flash RAM AES encrypted	Encryption of traffic between units in an HA cluster using AES

Alternating Bypass Feature

The primary cryptographic function of the module is as a firewall and VPN device. The module implements two forms of alternating bypass for VPN traffic: policy based (for IPSec and SSL VPN) and interface based (for IPSec VPN only).

Policy Based VPN

Firewall policies with an action of IPSec or SSL-VPN mean that the firewall is functioning as a VPN start/end point for the specified source/destination addresses and will encrypt/decrypt traffic according to the policy. Firewall policies with an action of allow mean that the firewall is accepting/sending plaintext data for the specified source/destination addresses.

A firewall policy with an action of accept means that the module is operating in a bypass state for that policy. A firewall policy with an action of IPSec or SSL-VPN means that the module is operating in a non-bypass state for that policy.

Interface Based VPN

Interface based VPN is supported for IPSec only. A virtual interface is created and any traffic routed to the virtual interface is encrypted and sent to the VPN peer. Traffic received from the peer is decrypted. Traffic through the virtual interface is controlled using firewall policies. However, unlike policy based VPN, the action is restricted to Accept or Deny and all traffic controlled by the policy is encrypted/decrypted.

When traffic is routed over the non-virtual interfaced, the module is operating in a bypass state. When traffic is routed over the virtual interface, the module is operating in a non-bypass state.

In both cases, two independent actions must be taken by a CO to create bypass firewall policies: the CO must create the bypass policy and then specifically enable that policy.

Key Archiving

The module supports key archiving to a management computer or USB token as part of a module configuration file backup. Operator entered keys are archived as part of the module configuration file. The configuration file is stored in plain text, but keys in the configuration file are either AES encrypted using the Configuration Encryption Key or stored as a keyed hash using HMAC-SHA-1 using the Configuration Backup Key.

Electromagnetic Interference/Electromagnetic Compatibility (EMI/EMC)

The modules comply with EMI/EMC requirements for Class A (business use) devices as specified by Part 15, Subpart B, of the FCC rules. The following table lists the specific lab and FCC report information for the modules.

Table 18: FCC Report Information

Module	Lab Information	FCC Report Number
FG-200B	Spectrum Research and Testing Laboratory, Inc No. 101-10, Ling 8 Shan-Tong Li Chung-Li City Taoyuan, Taiwan 03-498-7684 03-498-6528	FCBA09120101
FG-300C	The module is declared to conform with EMI/EMC requirements for Class B (business use) devices as specified by Part 15, Subpart B, of the FCC rules.	
FG-310B	Spectrum Research and Testing Laboratory, Inc No. 101-10, Ling 8 Shan-Tong Li Chung-Li City Taoyuan, Taiwan 03-498-7684 03-498-6528	FCAA08041001
FG-600C	The module is declared to conform with EMI/EMC requirements for Class B (business use) devices as specified by Part 15, Subpart B, of the FCC rules.	
FG-620B	Spectrum Research and Testing Laboratory, Inc No. 101-10, Ling 8 Shan-Tong Li Chung-Li City Taoyuan, Taiwan 03-498-7684 03-498-6528	FCBA08081403

Mitigation of Other Attacks

The module includes a real-time Intrusion Prevention System (IPS) as well as antivirus protection, antispam and content filtering. Use of these capabilities is optional.

The FortiOS IPS has two components: a signature based component for detecting attacks passing through the FortiGate appliance and a local attack detection component that protects the firewall from direct attacks. Functionally, signatures are similar to virus definitions, with each signature designed to detect a particular type of attack. The IPS signatures are updated through the FortiGuard IPS service. The IPS engine can also be updated through the FortiGuard IPS service.

FortiOS antivirus protection removes and optionally quarantines files infected by viruses from web (HTTP), file transfer (FTP), and email (POP3, IMAP, and SMTP) content as it passes through the FortiGate modules. FortiOS antivirus protection also controls the blocking of oversized files and supports blocking by file extension. Virus signatures are updated through the FortiGuard antivirus service. The antivirus engine can also be updated through the FortiGuard antivirus service.

FortiOS antispam protection tags (SMTP, IMAP, POP3) or discards (SMTP only) email messages determined to be spam. Multiple spam detection methods are supported including the FortiGuard managed antispam service.

FortiOS web filtering can be configured to provide web (HTTP) content filtering. FortiOS web filtering uses methods such as banned words, address block/exempt lists, and the FortiGuard managed content service.

Whenever a IPS, antivirus, antispam or filtering event occurs, the modules can record the event in the log and/or send an alert email to an operator.

For complete information refer to the FortiGate Installation Guide for the specific module in question, the FortiGate Administration Guide and the FortiGate IPS Guide.

FIPS 140-2 Compliant Operation

FIPS 140-2 compliant operation requires both that you use the module in its FIPS-CC mode of operation and that you follow secure procedures for installation and operation of the FortiGate unit. You must ensure that:

- The FortiGate unit is configured in the FIPS-CC mode of operation.
- The FortiGate unit is installed in a secure physical location.
- Physical access to the FortiGate unit is restricted to authorized operators.
- Administrative passwords are at least 8 characters long.
- Administrative passwords are changed regularly.
- Administrator account passwords must have the following characteristics:
 - One (or more) of the characters should be capitalized
 - One (or more) of the characters should be numeric
 - One (or more) of the characters should be non alpha-numeric (e.g. punctuation mark)
- Administration of the module is permitted using only validated administrative methods. These are:
 - Console connection
 - Web-based manager via HTTPS
 - Command line interface (CLI) access via SSH
- Diffie-Hellman groups of less than less than 1024 bits (Group 5) are not used.
- Client side RSA certificates must use 1024 bit or greater key sizes.
- LDAP based authentication must use secure LDAP (LDAPS).
- Only approved and allowed algorithms are used (see [“Algorithms” on page 21](#)).
- The tamper evident seals are applied (see [“Physical Security” on page 14](#)).

The module can be used in either of its two operation modes: NAT/Route or Transparent. NAT/Route mode applies security features between two or more different networks (for example, between a private network and the Internet). Transparent mode applies security features at any point in a network. The current operation mode is displayed on the web-based manager Status page and in the output of the `get system status` CLI command.

Enabling FIPS-CC mode

To enable the FIPS 140-2 compliant mode of operation, the operator must execute the following command from the Local Console:

```
config system fips
  set status enable
end
```

The Operator is required to supply a password for the admin account which will be assigned to the Crypto Officer role.

The supplied password must be at least 8 characters long and correctly verified before the system will restart in FIPS-CC mode.

Upon restart, the module will execute self-tests to ensure the correct initialization of the module's cryptographic functions.

After restarting, the Crypto Officer can confirm that the module is running in FIPS-CC mode by executing the following command from the CLI:

```
get system status
```

If the module is running in FIPS-CC mode, the system status output will display the line:

```
FIPS-CC mode: enable
```

Note that enabling/disabling the FIPS-CC mode of operation will automatically invoke the key zeroization service. The key zeroization is performed immediately after FIPS-CC mode is enabled/disabled.

Self-Tests

The module executes the following self-tests during startup and initialization:

- Firmware integrity test using RSA signatures
- Configuration/VPN bypass test using HMAC SHA-1
- Triple-DES, CBC mode, encrypt known answer test
- Triple-DES, CBC mode, decrypt known answer test
- AES, CBC mode, encrypt known answer test
- AES, CBC mode, decrypt known answer test
- HMAC SHA-1 known answer test
- SHA-1 known answer test (test as part of HMAC SHA-1 known answer test)
- HMAC SHA-256 known answer test
- SHA-256 known answer test (test as part of HMAC SHA-256 known answer test)
- RSA signature generation known answer test
- RSA signature verification known answer test
- RNG known answer test

The results of the startup self-tests are displayed on the console during the startup process. The startup self-tests can also be initiated on demand using the CLI command **execute fips kat all** (to initiate all self-tests) or **execute fips kat <test>** (to initiate a specific self-test).

When the self-tests are run, each implementation of an algorithm is tested - e.g. when the AES self-test is run, all AES implementations are tested.

The module executes the following conditional tests when the related service is invoked:

- Continuous RNG test
- Continuous NDRNG test
- RSA pairwise consistency test
- Configuration/VPN bypass test using HMAC SHA-1
- Firmware load test using RSA signatures

If any of the self-tests or conditional tests fail, the module enters an error state as shown by the console output below:

```
Self-tests failed
Entering error mode...
The system is going down NOW !!
The system is halted.
```

All data output and cryptographic services are inhibited in the error state.

Non-FIPS Approved Services

The module also provides the following non-FIPS approved services:

- Configuration backups using password protection
- LLTP and PPTP VPN
- Paired Bypass network interfaces (WAN1/Port1 and WAN2/Port2)

If the above services are used, the module is not considered to be operating in the FIPS approved mode of operation.