

FIPS 140-2 Non-Proprietary Security Policy

FortiGate-600D/1200D/1500D/3000D/3700D and FortiGate-5001D with FortiGate-5144C Chassis

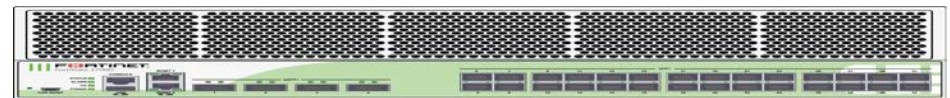

FortiGate-600D/1200D/1500D/3000D/3700D and FortiGate-5001D with FortiGate-5144C Chassis FIPS 140-2 Level 2 Non-Proprietary Security Policy	
Document Version:	2.3
Publication Date:	Tuesday, October 26, 2021
Description:	Documents FIPS 140-2 Level 2 Security Policy issues, compliancy and requirements for FIPS compliant operation.
Firmware Version:	FortiOS 6.0 build 5445 and FortiOS 6.2 build 5548

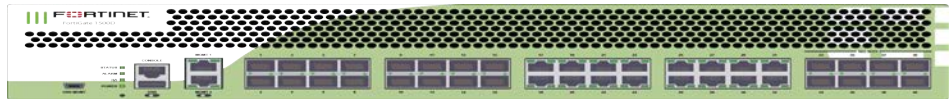
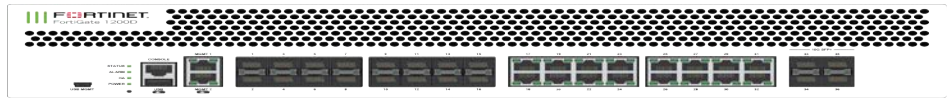
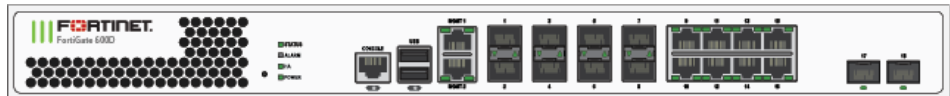
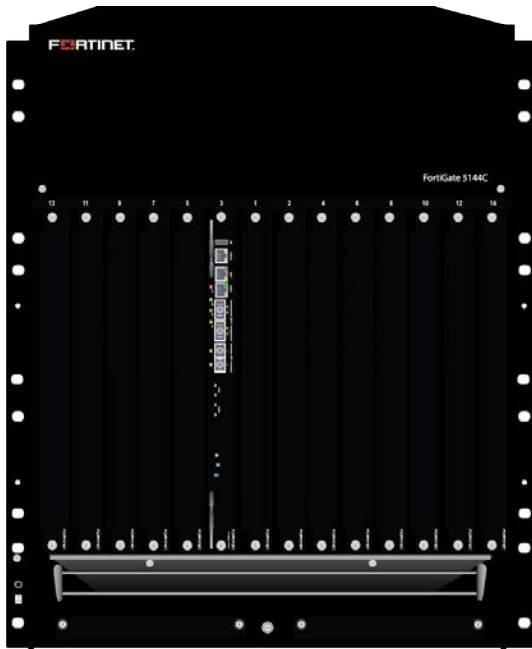
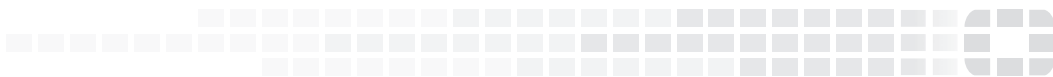

Hardware Version:	FortiGate-5001D (C1AA92) with Tamper Evident Seal Kit: FIPS-SEAL-RED	Blank Filler Panel - Front (P16708-01)	
	FortiGate-5144C (C1AB98) with Tamper Evident Seal Kit: FIPS-SEAL-RED	Blank Filler Panel - Rear (P16710-01)	
	XXXXXXXXXXXXXXXXXXXXXX	XXXXXXXXXXXXXXXXXXXXXX	XXXXXXXXXXXXXXXXXXXXXX
	FortiGate-1500D (C1AA64) with Tamper Evident Seal Kit: FIPS-SEAL-RED	FortiGate-3700D (C1AA92) with Tamper Evident Seal Kit: FIPS-SEAL-RED	FortiGate-3000D (C1AC63) with Tamper Evident Seal Kit: FIPS-SEAL-RED
	FortiGate-600D (C1AE11) with Tamper Evident Seal Kit: FIPS-SEAL-RED	FortiGate-1200D (C1AC57) with Tamper Evident Seal Kit: FIPS-SEAL-RED	

FORTINET DOCUMENT LIBRARY

<https://docs.fortinet.com>

FORTINET VIDEO GUIDE

<https://video.fortinet.com>

FORTINET KNOWLEDGE BASE

<http://kb.fortinet.com>

FORTINET BLOG

<https://blog.fortinet.com>

CUSTOMER SERVICE & SUPPORT

<https://www.fortinet.com/support/contact.html>

FORTINET NSE INSTITUTE (TRAINING)

<https://training.fortinet.com/>

FORTIGUARD CENTER

<https://fortiguard.com>

FORTICAST

<http://forticast.fortinet.com>

END USER LICENSE AGREEMENT AND PRIVACY POLICY

<https://www.fortinet.com/doc/legal/EULA.pdf>

<https://www.fortinet.com/corporate/about-us/privacy.html>

FEEDBACK

Email: techdoc@fortinet.com



Tuesday, October 26, 2021

FortiGate-600D/1200D/1500D/3000D/3700D and FortiGate-5001D with FortiGate-5144C Chassis FIPS 140-2 Non-Proprietary Security Policy

01-600-582618-20190913

FORTINET DOCUMENT LIBRARY

<https://docs.fortinet.com>

FORTINET VIDEO GUIDE

<https://video.fortinet.com>

FORTINET KNOWLEDGE BASE

<http://kb.fortinet.com>

FORTINET BLOG

<https://blog.fortinet.com>

CUSTOMER SERVICE & SUPPORT

<https://www.fortinet.com/support/contact.html>

FORTINET NSE INSTITUTE (TRAINING)

<https://training.fortinet.com/>

FORTIGUARD CENTER

<https://fortiguard.com>

FORTICAST

<http://forticast.fortinet.com>

END USER LICENSE AGREEMENT AND PRIVACY POLICY

<https://www.fortinet.com/doc/legal/EULA.pdf>

<https://www.fortinet.com/corporate/about-us/privacy.html>

FEEDBACK

Email: techdoc@fortinet.com



This document may be freely reproduced and distributed whole and intact when including the copyright notice found on the last page of this document.

TABLE OF CONTENTS

Overview	7
References.....	7
Introduction	8
Security Level Summary	9
Module Descriptions	10
FortiGate-5144C Chassis Description.....	11
Cryptographic Module Ports and Interfaces.....	11
FortiGate-5144C Chassis.....	16
FortiGate-600D.....	19
FortiGate-1200D.....	20
FortiGate-1500D.....	22
FortiGate-3000D.....	23
FortiGate-3700D.....	25
Web-Based Manager.....	26
Command Line Interface.....	26
Roles, Services and Authentication.....	27
Roles.....	27
FIPS Approved Services.....	27
Non-FIPS Approved Services.....	29
Authentication.....	30
Physical Security.....	31
Operational Environment.....	39
Cryptographic Key Management.....	39
Random Number Generation.....	39
Entropy.....	39
Key Zeroization.....	40
Algorithms.....	40
Cryptographic Keys and Critical Security Parameters.....	43
Alternating Bypass Feature.....	47
Key Archiving.....	48
Mitigation of Other Attacks.....	48
Electromagnetic Interference/Electromagnetic Compatibility (EMI/EMC)	50
FIPS 140-2 Compliant Operation	51
Enabling FIPS-CC mode.....	52
Self-Tests	53
Startup and Initialization Self-tests.....	53
Conditional Self-tests.....	53

Critical Function Self-tests.....	54
Error State.....	54

Overview

This document is a FIPS 140-2 Security Policy for Fortinet Incorporated's FortiGate-600D, 1200D, 1500D, 3000D, 3700D and 5144C chassis with the FortiGate-5001D blade based Next Generation Firewall. This policy describes how the FortiGate-5001D blade, when installed in the FortiGate-5144C chassis (hereafter referred to in combination as the 'module'), and the FortiGate-600D, 1200D, 1500D, 3000D, 3700D meet the FIPS 140-2 security requirements and how to operate the module in a FIPS compliant manner. This policy was created as part of the Level 2 FIPS 140-2 validation of the module.

The Federal Information Processing Standards Publication 140-2 - *Security Requirements for Cryptographic Modules* (FIPS 140-2) details the United States Federal Government requirements for cryptographic modules. Detailed information about the FIPS 140-2 standard and validation program is available on the NIST (National Institute of Standards and Technology) website at <http://csrc.nist.gov/groups/STM/cmvp/index.html>.

References

This policy deals specifically with operation and implementation of the modules in the technical terms of the FIPS 140-2 standard and the associated validation program. Other Fortinet product manuals, guides and technical notes can be found at the Fortinet technical documentation website at <https://docs.fortinet.com>.

Additional information on the entire Fortinet product line can be obtained from the following sources:

- Find general product information in the product section of the Fortinet corporate website at <https://www.fortinet.com/products>.
- Find on-line product support for registered products in the technical support section of the Fortinet corporate website at <https://www.fortinet.com/support>.
- Find contact information for technical or sales related questions in the contacts section of the Fortinet corporate website at <https://www.fortinet.com/contact>.
- Find security information and bulletins in the FortiGuard Center of the Fortinet corporate website at <https://www.fortiguard.com>.

Introduction

The FortiGate family of Next Generation Firewalls spans the full range of network environments, from SOHO to service provider, offering cost effective systems for any size of application. FortiGate appliances detect and eliminate the most damaging, content-based threats from email and Web traffic such as viruses, worms, intrusions, inappropriate Web content and more in real time — without degrading network performance. In addition to providing application level firewall protection, FortiGate appliances deliver a full range of network-level services — VPN, intrusion prevention, web filtering, antivirus, antispam and traffic shaping — in dedicated, easily managed platforms.

All FortiGate appliances employ Fortinet's unique FortiASIC content processing chip and the powerful, secure, FortiOS firmware achieve breakthrough price/performance. The unique, ASIC-based architecture analyzes content and behavior in real time, enabling key applications to be deployed right at the network edge where they are most effective at protecting enterprise networks. They can be easily configured to provide antivirus protection, antispam protection and content filtering in conjunction with existing firewall, VPN, and related devices, or as complete network protection systems. The modules support High Availability (HA) in both Active-Active (AA) and Active-Passive (AP) configurations.

FortiGate appliances support the IPsec industry standard for VPN, allowing VPNs to be configured between a FortiGate appliance and any client or gateway/firewall that supports IPsec VPN. FortiGate appliances also provide SSL VPN services using TLS 1.1 and 1.2.

Security Level Summary

The modules meet the overall requirements for a FIPS 140-2 Level 2 validation.

Table 1: Summary of FIPS security requirements and compliance levels

Security Requirement	Compliance Level
Cryptographic Module Specification	2
Cryptographic Module Ports and Interfaces	2
Roles, Services and Authentication	3
Finite State Model	2
Physical Security	2
Operational Environment	N/A
Cryptographic Key Management	2
EMI/EMC	2
Self-Tests	2
Design Assurance	2
Mitigation of Other Attacks	2

Module Descriptions

The FortiGate-5001D is an ATCA, blade based, multiple chip, standalone cryptographic module consisting of production grade components contained in a physically protected enclosure in accordance with FIPS 140-2 Level 2 requirements.

The FortiGate-5001D blade runs the FortiOS firmware, performs all of the cryptographic functions and provides the input/output interfaces. The FortiGate-5144C chassis provides power, cooling and physical protection for the module as a whole. The chassis does not run FortiOS firmware. The extent of the cryptographic boundary for the module is the outer metal chassis.

The FortiGate-600D, 1200D, 1500D, 3000D, and 3700D modules are multiple chip, standalone cryptographic modules consisting of production grade components contained in a physically protected enclosure in accordance with FIPS 140-2 Level 2 requirements. The extent of the cryptographic boundary for all modules is the outer metal chassis.

The modules are Internet devices that provide integrated firewall, VPN, antivirus, antispam, intrusion prevention, content filtering and traffic shaping and HA capabilities. This FIPS 140-2 Security Policy specifically covers the firewall, IPSec and SSL-VPN capabilities of the modules.

The antivirus, antispam, intrusion prevention, content filtering and traffic shaping capabilities of the modules can be used without compromising the FIPS approved mode of operation.

The FortiGate-5001D has 6 network interfaces with status LEDs for each network interface (2x 40GB QSFP+, 2x 10GB SFP+, 2x 10/100/1000 Base-T).

The FortiGate-600D has 20 network interfaces status LEDs for each network interface (10x 10/100/1000 Base-T, 8x 1GB SFP, 2x 10GB SFP+).

The FortiGate-1200D has 38 network interfaces with status LEDs for each network interface (18x 10/100/1000 Base-T, 16x 1GB SFP, 4x 10GB SFP+).

The FortiGate-1500D has 42 network interfaces with status LEDs for each network interface (18x 10/100/1000 Base-T, 16x 1GB SFP, 8x 10GB SFP+).

The FortiGate-3000D has 18 network interfaces with status LEDs for each network interface (2x 10/100/1000 Base-T, 16x 10GB SFP+)

The FortiGate-3700D has 34 network interfaces with status LEDs for each network interface (2x 10/100/1000 Base-T, 28x 10GB SFP+, 4x 40GB QSFP+).

The FortiGate-5001D module has one x86 compatible CPU.

The FortiGate-600D, 1200D, 1500D and 3000D each have one x86 compatible CPU.

The FortiGate-3700D has two x86 compatible CPUs.

The FortiGate-600D is a 1U rackmount device.

The FortiGate-1200D, 1500D and 3000D are 2U rackmount devices.

The FortiGate-3700D is a 3u rackmount device.

The validated firmware versions are FortiOS 6.0 build 5445 and FortiOS 6.2 build 5548. Any firmware loaded into the module that is not shown on the module certificate, is out of the scope of this validation and requires a separate FIPS 140-2 validation.

Figure 1 is representative of the FortiGate-5001D blade. Figure 2 is representative of the complete module including the FortiGate-5001D blade and the FortiGate-5144C chassis.

Figures 4 - 8 are representative of the Fortigate-600D, 1200D, 1500D, 3000D, and 3700D.

FortiGate-5144C Chassis Description

The FortiGate-5144C has 4 hot swappable, internal ventilation fan units that draw in air from the bottom front of the chassis and expel it from the top rear.

The FortiGate-5144C uses four, hot-swappable, DC power entry modules (PEMs). These PEMs are excluded and only connect to the internal chassis power interface.

The FortiGate-5144C chassis uses an external DC power source.

The FortiGate-5144C chassis supports removable Shelf Managers (2). The module remains opaque without them. These panels are excluded from the requirements of FIPS 140-2, as they perform no security relevant function.

The FortiGate-5144C chassis includes slots for rear-panel blades. However, the rear panel slots are not populated in the validated configuration.

Cryptographic Module Ports and Interfaces

Figure 1 - FortiGate-5001D Front Panel

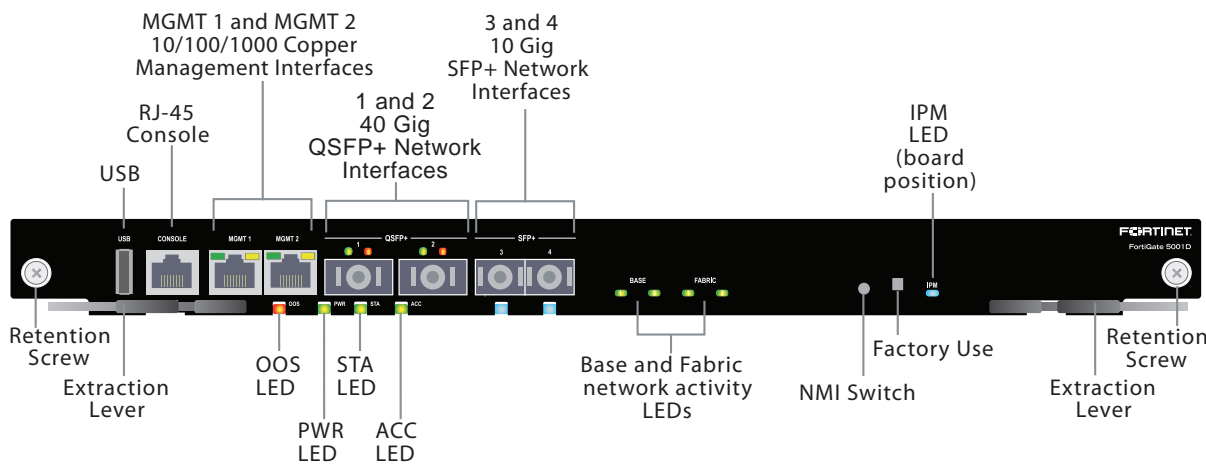

Table 2: FortiGate-5001D Status LEDs, Port 1s and 2, 40Gbit Mode

Green LED (left)	Amber LED (right)	Description
On	Off	The correct cable is connected to the interface and the connected equipment has power.
Off	Off	No link is established.

Table 3: FortiGate-5001D Status LEDs, Port 1s and 2, 4x 40Gbit Mode

Green LED (left)	Amber LED (right)	Description
Flashing	On	The correct cables are connected to the interface, the connected equipment has power and all 10Gbit interfaces are connected.
Flashing	Flashing	The correct cables are connected to the interface, the connected equipment has power and only some of the 10Gbit interfaces are connected.
Off	Off	No link is established.

Table 4: Other FortiGate-5001D Status LEDs

LED		State	Description
MGMT 1 and 2	Link/Act (Left LED)	Green	The correct cable is connected to the interface and the connected equipment has power.
		Flashing	Network activity at the interface.
		Off	No link established.
	Speed (Right LED)	Green	Connected at 1 Gbps.
		Amber	Connected at 100 Mbps.
		Off	Connected at 10 Mbps.
Ports 3 and 4		Green	The correct cable is connected to the interface and the connected equipment has power.
		Flashing Green	Port is sending/receiving data.
		Off	No link established.
Base 1 and 2		Green	Base backplane interface is connected at 1 Gbps.
		Flashing Green	Network activity at the interface.
		Off	No link is established.
Base 1 and 2		Green	Base backplane interface is connected at 1 Gbps.
		Flashing Green	Network activity at base backplane interface.
Fabric 1 and 2		Green	Fabric backplane interface is connected at 10 Gbps.
		Flashing Green	Network activity at fabric backplane interface.
ACC (Disk Activity)		Off or Flashing green	The ACC LED flashes green when the FortiGate-5001D blade accesses its internal storage. The storage contains the current FortiOS firmware build and configuration files. The system accesses the storage when starting up, during a firmware upgrade, or when an administrator is using the CLI or GUI to change the FortiOS configuration. Under normal operating conditions this LED flashes occasionally, but is mostly off.

LED	State	Description
OOS (Out of Service)	Off	Normal operation.
	Green	A fault condition exists and the FortiGate- 5001D blade is out of service (OOS). This LED may also flash very briefly during normal startup.
PWR (Power)	Green	The FortiGate-5001D blade is powered on.
STA (Status)	Off	The FortiGate-5001D blade is powered on.
	Flashing Green	The FortiGate-5001D is starting up. If this LED is flashing at any time other than system startup, a fault condition may exist.
IPM	Blue	The FortiGate-5001D is ready to be hotswapped (removed from the chassis). If the IPM light is blue and no other LEDs are lit the FortiGate-5001A blade has lost power.
	Flashing Blue	The FortiGate-5001D board is changing from hot swap to running mode or from running mode to hot swap. This happens when the FortiGate-5001D board is starting up or shutting down.
	Off	Normal operation. The FortiGate-5001D board is in contact with the chassis backplane.

Table 5: FortiGate-5001D Front Panel Connectors and Ports

Connector	Type	Speed	Supported Logical Interfaces	Description
MGMT Ports 1 & 2	RJ-45	10/100/1000 Base-T	Data input, data output, control input and status output	Connection to 10/100/1000 networks.
Ports 1 and 2	QSFP+	40 Gbps	Data input, data output, control input and status output	Connection to QSFP+ networks.
Ports 3 and 4	SFP+	10 Gbps	Data input, data output, control input and status output	Connection to SFP+ networks.
Console Port	RJ-45	9600 bps	Control input, status output	Optional connection to the management computer. Provides access to the command line interface (CLI).
USB Port	USB A	N/A	Data input, data output	Optional USB token and entropy token. Key loading and archiving.

Figure 2 - FortiGate-5001D Rear Blade Connectors**Table 6: FortiGate-5001D Rear Blade Connectors**

Connector	Type	Speed	Supported Logical Interfaces	Description
Power Connector	ATCA Zone 1	N/A	N/A	High power connection to ATCA chassis backplane.
High Speed Signal Connector	ATCA Zone 2	10 Gbps	Data input, data output, control input and status output	High speed connection to ATCA chassis backplane.

FortiGate-5144C Chassis

Figure 3 - FortiGate-5144C Front Panel

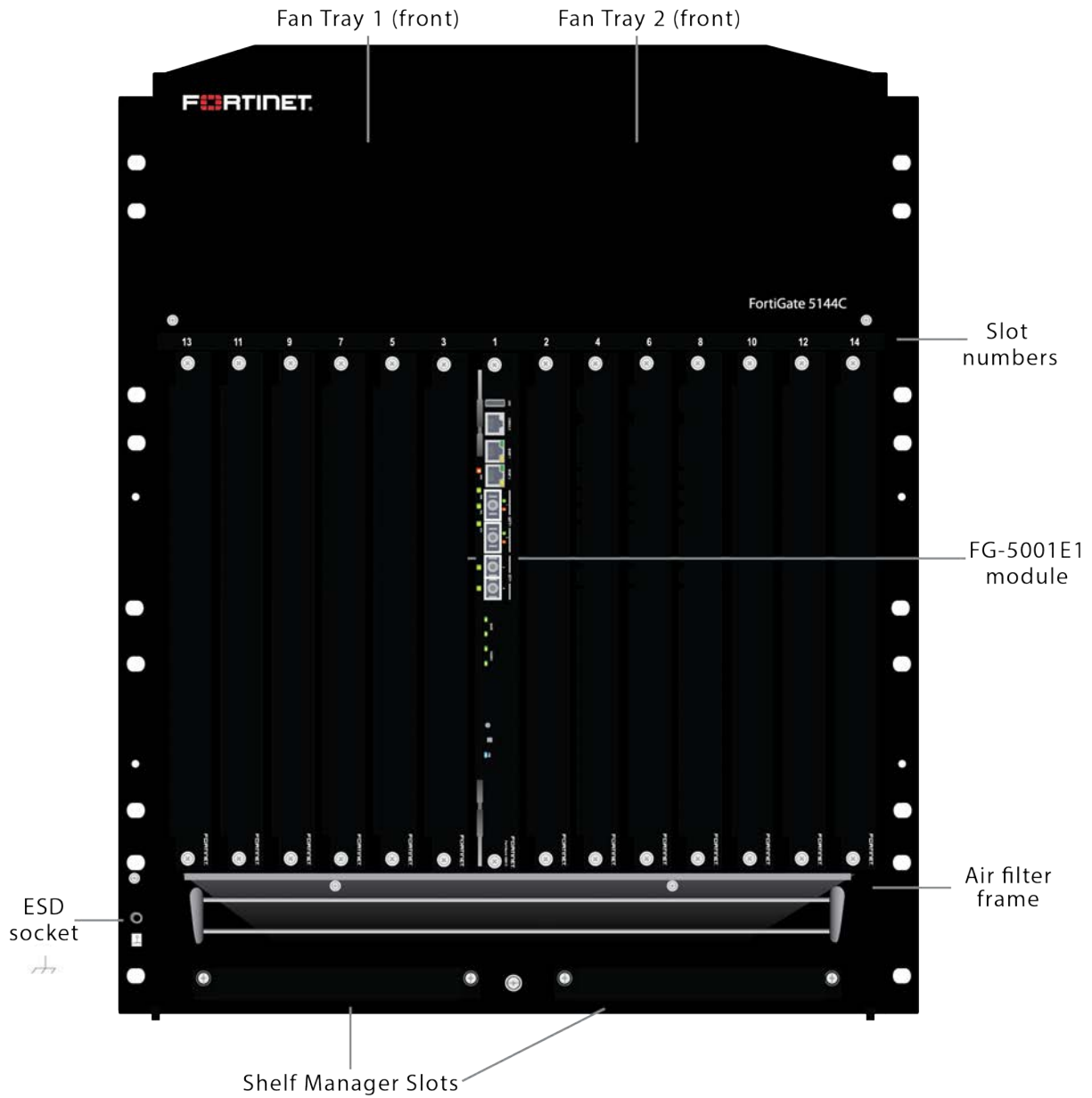
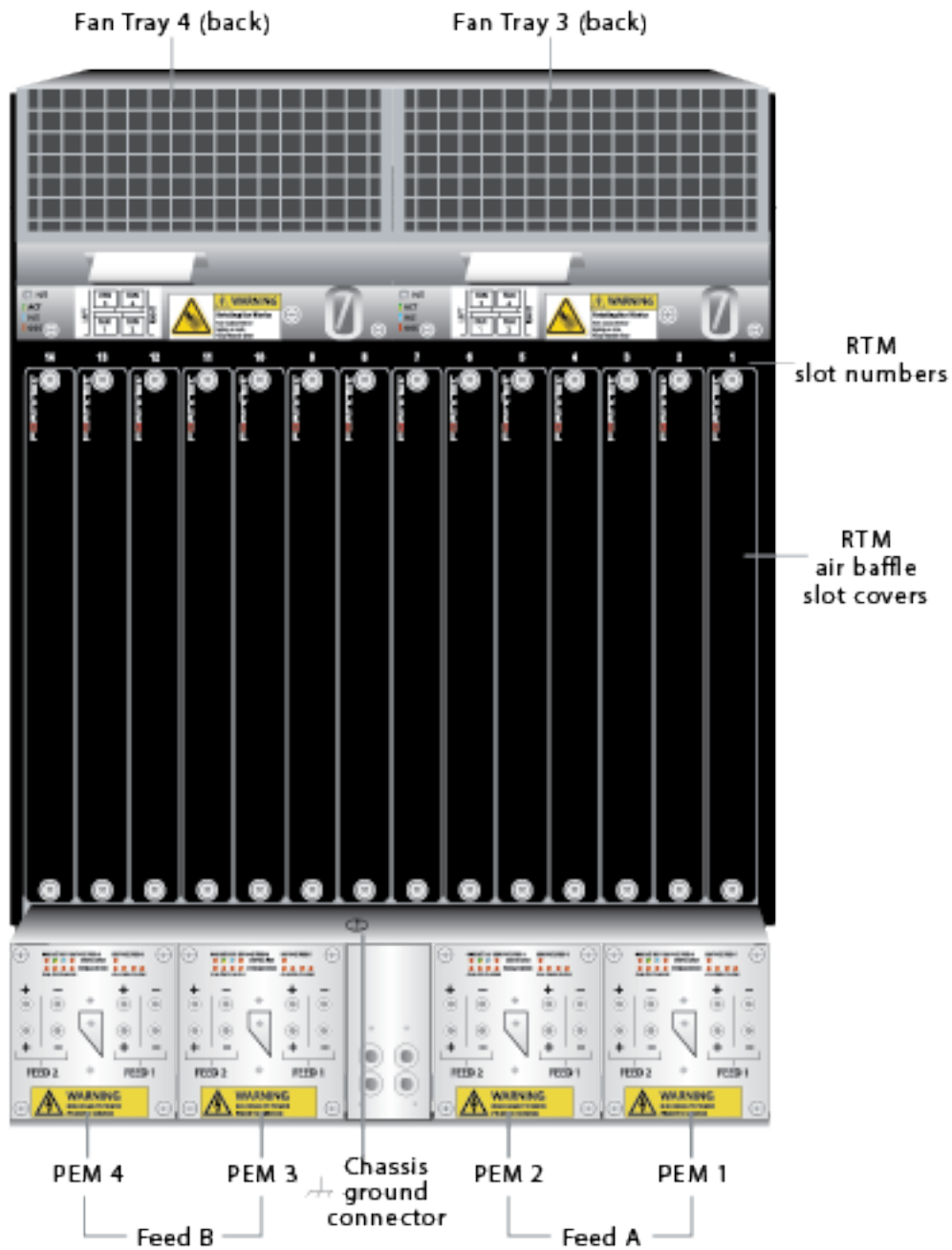

Figure 4 - FortiGate-5144C Rear Panel



All of the FortiGate-600D, 1200D, 1500D, 3000D, and 3700D modules have status LEDs as described in the following table:

Table 7: Module Status LEDs

LED	State	Description	
Power	Green	The module is powered on.	
	Off	The module is powered off.	
Status	Green	The module is running normally.	
	Flashing	The module is starting up.	
	Off	The module is powered off.	
HA	Green	HA is enabled.	
	Off	The unit is in standalone mode.	
Alarm	Red	The unit has a major alarm.	
	Amber	The unit has a minor alarm.	
	Off	The unit is operating normally.	
Ethernet Ports	Link/ACT	Green	Port is connected.
		Flashing	Port is sending/receiving data.
		Off	No link established.
	Speed	Green	Connected at 1000 Mbps.
		Amber	Connected at 100 Mbps
		Off	Connected at 10 Mbps
	SFP, SFP+, QSFP+ and CSFP Ports	Green	Port is connected.
		Flashing	Port is sending/receiving data.
		Off	No link established.

FortiGate-600D

Figure 5 - FortiGate-600D Front and Rear Panels

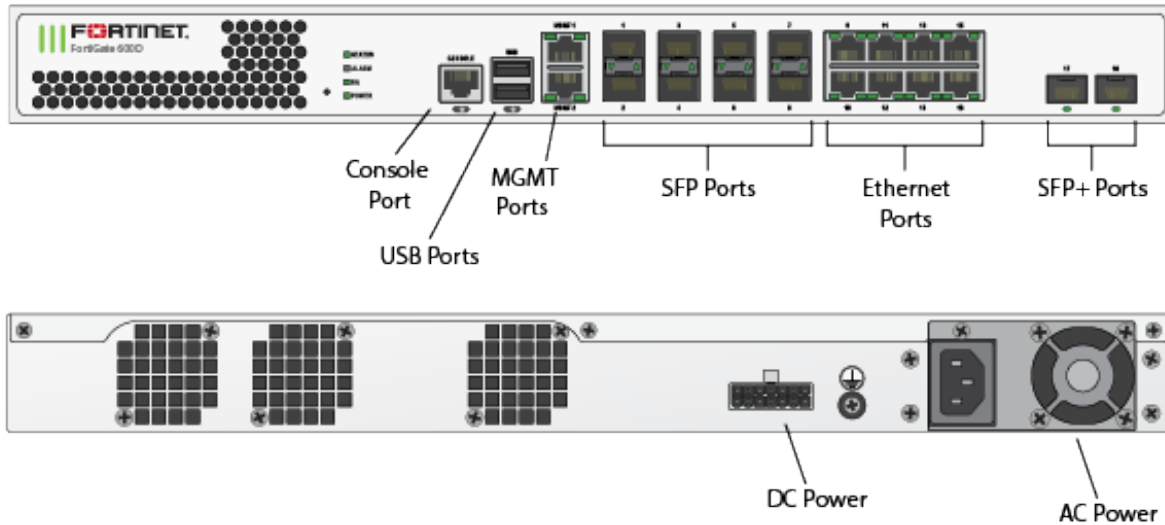

Table 8: FortiGate-600D Connectors and Ports

Connector	Type	Speed	Supported Logical Interfaces	Description
MGMT Ports and Ports 9-16	RJ-45	10/100/1000 Base-T	Data input, data output, control input, and status output	Copper gigabit connection to 10/100/1000 copper networks.
Ports 1-8	SFP	1 Gbps	Data input, data output, control input and status output	Multimode fiber optic connections to gigabit optical networks.
Ports 17-18	SFP+	10 Gbps	Data input, data output, control input and status output	Multimode fiber optic connections to gigabit optical networks.
USB Ports	USB-A	N/A	Data input, data output	Entropy token, configuration loading and archiving.
Console Port	RJ-45	9600 bps	Control input, status output	Optional connection to the management computer. Provides access to the command line interface (CLI).

Connector	Type	Speed	Supported Logical Interfaces	Description
DC Power	N/A	N/A	Power	+12VDC power connection
AC Power	N/A	N/A	Power	120/240VAC power connection.

FortiGate-1200D

Figure 6 - FortiGate-1200D Front and Rear Panels

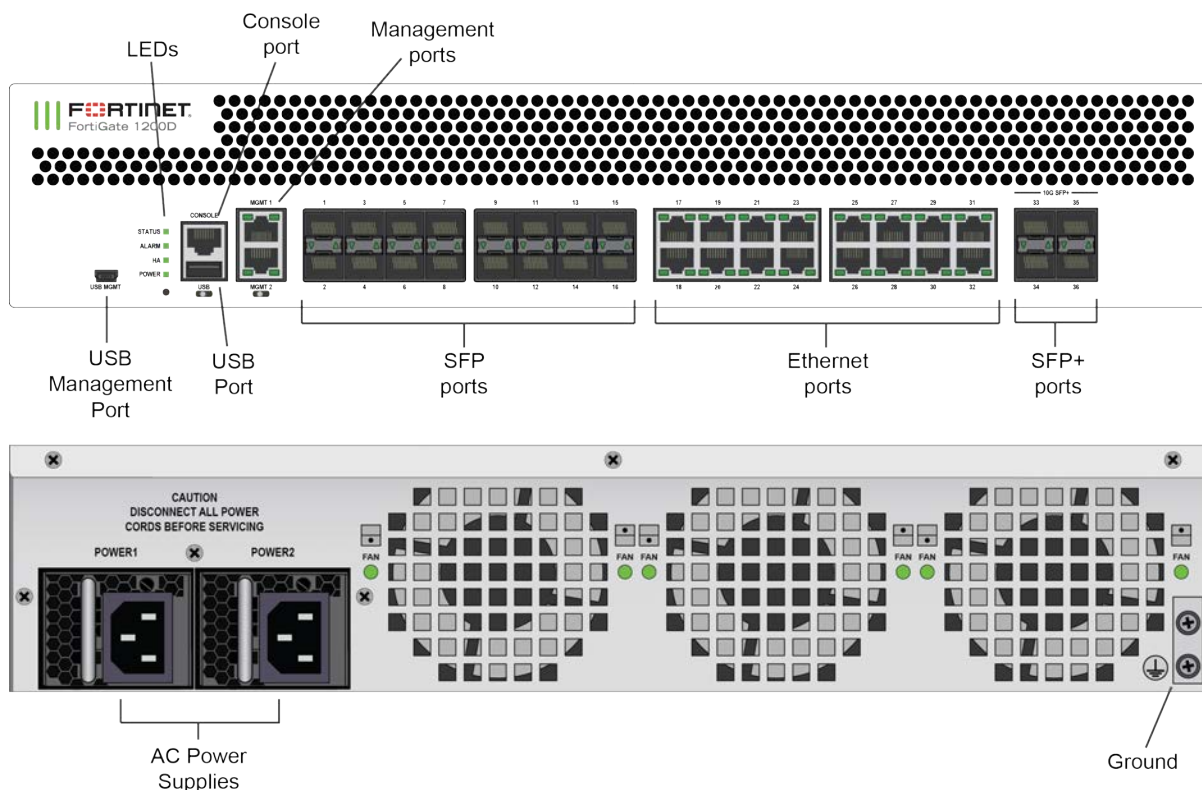

Table 9: FortiGate-1200D Connectors and Ports

Connector	Type	Speed	Supported Logical Interfaces	Description
MGMT Ports	RJ-45	10/100/1000 Base-T	Data input, data output, control input, and status output	Copper gigabit connection to 10/100/1000 copper networks.
Ports 1-16	SFP	1 Gbps	Data input, data output, control input, and status output	Multimode fiber optic connections to gigabit optical networks.

Connector	Type	Speed	Supported Logical Interfaces	Description
Ports 17-32	RJ-45	10/100/1000 Base-T	Data input, data output, control input, and status output	Copper gigabit connection to 10/100/1000 copper networks.
Ports 33-36	SFP+	10 Gbps	Data input, data output, control input, and status output	Multimode fiber optic connections to gigabit optical networks.
USB Port	USB-A	N/A	Data input, data output	Configuration loading and archiving.
USB Management Port	USB Mini-B	N/A	Control input, data output	Configuration loading and archiving.
Console Port	RJ-45	9600 bps	Control input, status output	Optional connection to the management computer. Provides access to the command line interface (CLI).
AC Power	N/A	N/A	Power	120/240VAC power connection.

FortiGate-1500D

Figure 7 - FortiGate-1500D Front and Rear Panels

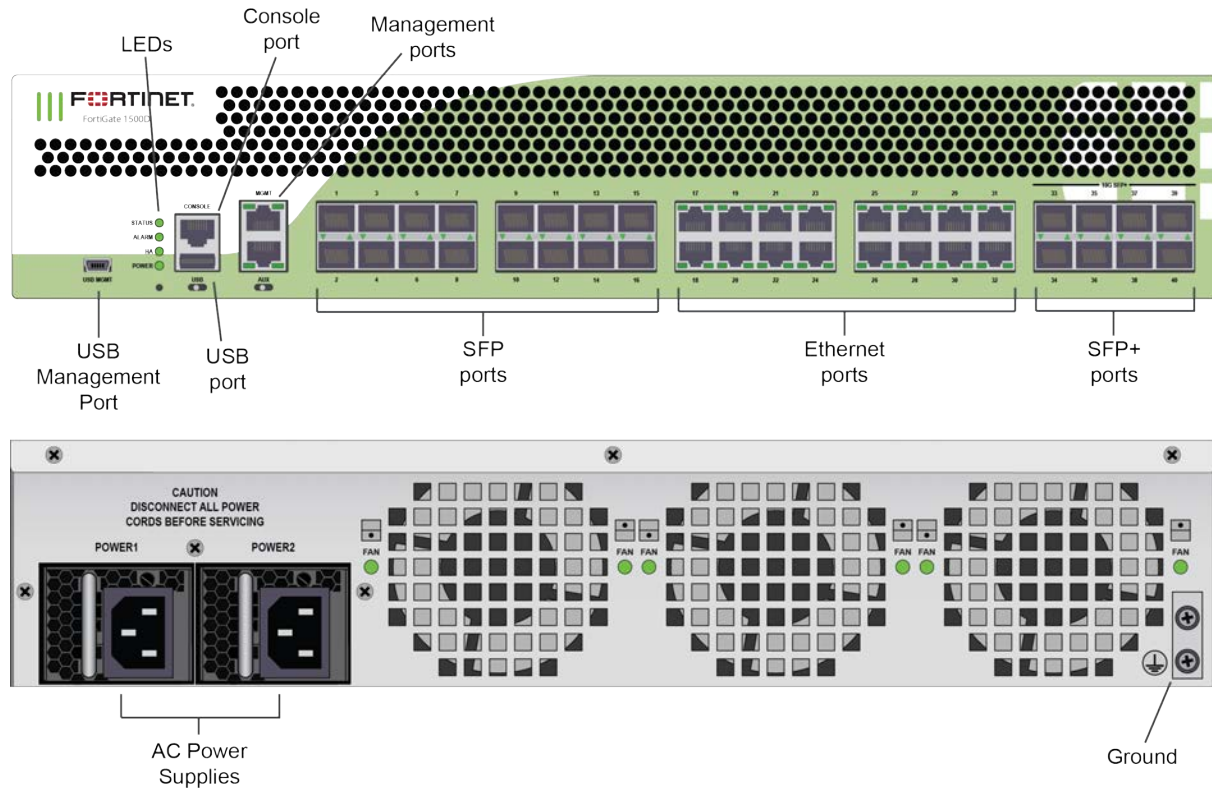

Table 10: FortiGate-1500D Connectors and Ports

Connector	Type	Speed	Supported Logical Interfaces	Description
MGMT Ports	RJ-45	10/100/1000 Base-T	Data input, data output, control input, and status output	Copper gigabit connection to 10/100/1000 copper networks.
Ports 1-16	SFP	1 Gbps	Data input, data output, control input, and status output	Multimode fiber optic connections to gigabit optical networks.
Ports 17-32	RJ-45	10/100/1000 Base-T	Data input, data output, control input, and status output	Copper gigabit connection to 10/100/1000 copper networks.

Connector	Type	Speed	Supported Logical Interfaces	Description
Ports 33-40	SFP+	10 Gbps	Data input, data output, control input, and status output	Multimode fiber optic connections to gigabit optical networks.
USB Port	USB-A	N/A	Data input, data output	Configuration loading and archiving.
USB Management Port	USB Mini-B	N/A	Control input, data output	Configuration loading and archiving.
Console Port	RJ-45	9600 bps	Control input, status output	Optional connection to the management computer. Provides access to the command line interface (CLI).
AC Power	N/A	N/A	Power	120/240VAC power connection.

FortiGate-3000D

Figure 8 - FortiGate-3000D Front and Rear Panels

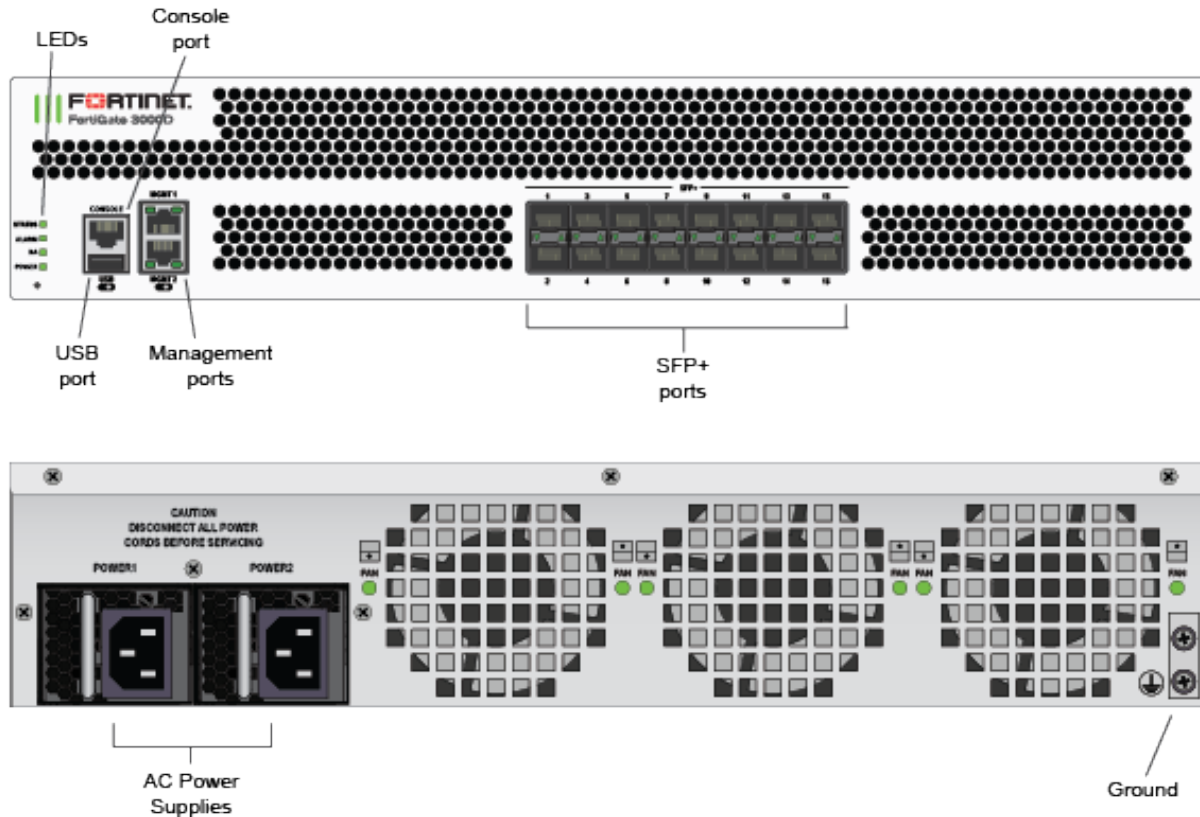

Table 11: FortiGate-3000D Connectors and Ports

Connector	Type	Speed	Supported Logical Interfaces	Description
MGMT Ports	RJ-45	10/100/1000 Base-T	Data input, data output, control input, and status output	Copper gigabit connection to 10/100/1000 copper networks.
Ports 1-16	SFP+	10 Gbps	Data input, data output, control input, and status output	Multimode fiber optic connections to gigabit optical networks.
USB Port	USB-A	N/A	Data input, data output	Configuration loading and archiving.
Console Port	RJ-45	9600 bps	Control input, status output	Optional connection to the management computer. Provides access to the command line interface (CLI).
AC Power	N/A	N/A	Power	120/240VAC power connection.

FortiGate-3700D

Figure 9 - FortiGate-3700D Front and Rear Panels

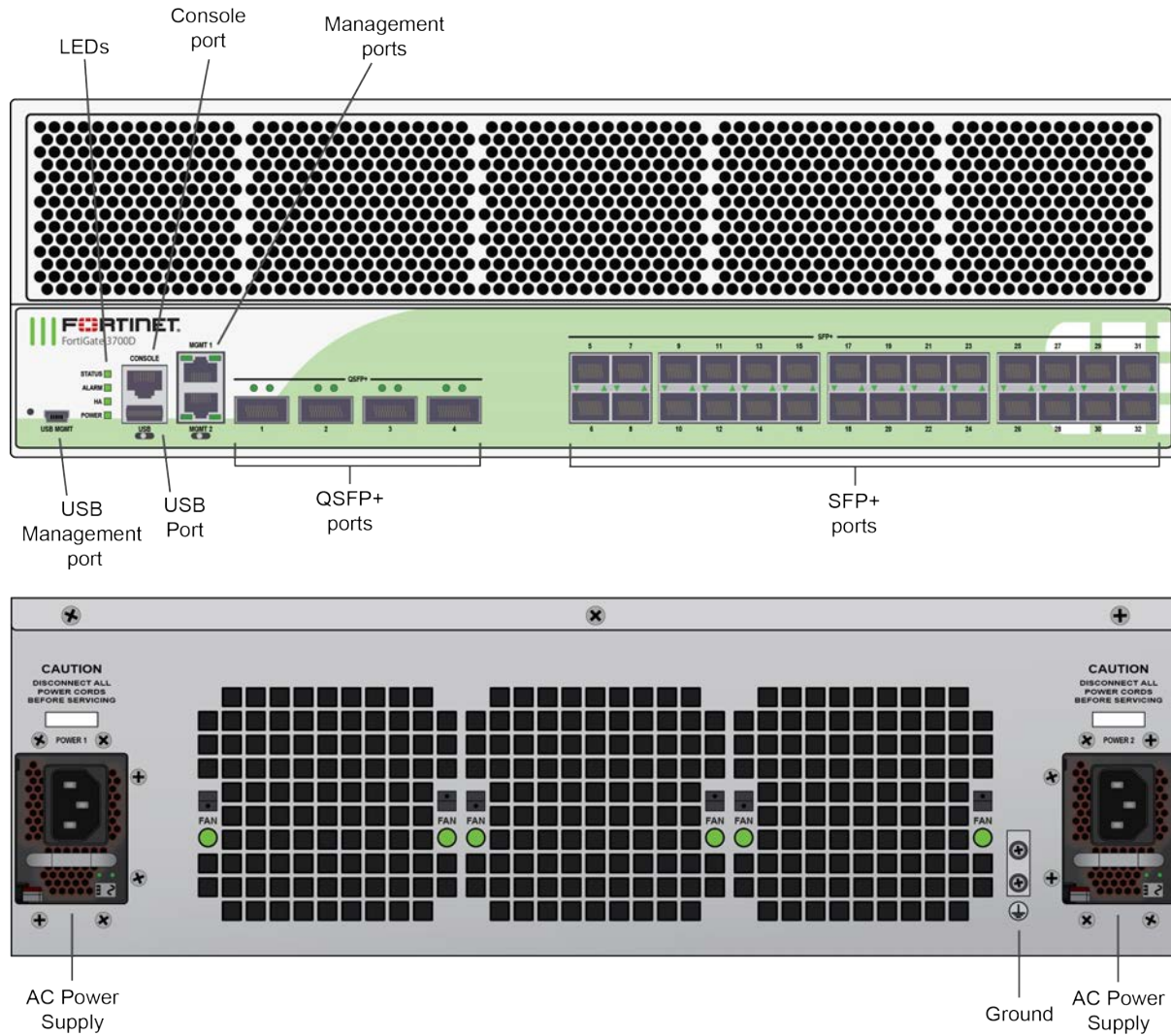

Table 12: FortiGate-3700D Connectors and Ports

Connector	Type	Speed	Supported Logical Interfaces	Description
MGMT Ports	RJ-45	10/100/1000 Base-T	Data input, data output, control input and status output	Connection to 10/100/1000 networks.
Ports 1-4	QSFP+	40 Gbps	Data input, data output, control input and status output	Multimode fiber optic connections to gigabit optical networks.

Connector	Type	Speed	Supported Logical Interfaces	Description
Ports 5-32	SFP	10 Gbps	Data input, data output, control input and status output	Multimode fiber optic connections to gigabit optical networks.
Console Port	RJ-45	9600 bps	Control input, status output	Optional connection to the management computer. Provides access to the command line interface (CLI).
USB Port	USB A	N/A	Data input, data output	Configuration loading and archiving.
USB Management Port	USB B	N/A	Control input, status output	Optional connection to the management computer. Provides access to the command line interface (CLI).
AC POWER	N/A	N/A	Power	120/240VAC power connection.

Web-Based Manager

The FortiGate web-based manager provides GUI based access to the modules and is the primary tool for configuring the modules. The manager requires a web browser on the management computer and an Ethernet connection between the FortiGate unit and the management computer.

A web-browser that supports Transport Layer Security (TLS) 1.1 or 1.2 is required for remote access to the web-based manager when the module is operating in FIPS-CC mode. HTTP access to the web-based manager is not allowed in FIPS-CC mode and is disabled.

Command Line Interface

The FortiGate Command Line Interface (CLI) is a full-featured, text based management tool for the module. The CLI provides access to all of the possible services and configuration options in the module. The CLI uses a console connection or a network (Ethernet) connection between the FortiGate unit and the management computer. The console connection is a direct serial connection. Terminal emulation software is required on the management computer using either method. For network access, a Telnet or SSH client that supports the SSH v2.0 protocol is required (SSH v1.0 is not supported in FIPS-CC mode). Telnet access to the CLI is not allowed in FIPS-CC mode and is disabled.

Roles, Services and Authentication

Roles

When configured in FIPS-CC mode, the module provides the following roles:

- Crypto Officer
- Network User

The Crypto Officer role is initially assigned to the default 'admin' operator account. The Crypto Officer role has read-write-execute access to all of the module's administrative services. The initial Crypto Officer can create additional operator accounts. These additional accounts are assigned the Crypto Officer role and can be assigned a range of read-write-execute or read only access permissions including the ability to create operator accounts.

The modules also provide a Network User role for end-users (Users). Network Users can make use of the encrypt/decrypt services, but cannot access the modules for administrative purposes.

The module does not provide a Maintenance role.

FIPS Approved Services

The following tables detail the types of FIPS approved services available to each role in each mode of operation, the types of access for each role and the Keys or CSPs they affect.

The access types are abbreviated as follows:

Read Access	R
Write Access	W
Execute Access	E

Table 13: Services available to Crypto Officers

Service	Access	Key/CSP
connect to module locally using the console port	WE	N/A
connect to module remotely using TLS*	WE	Diffie-Hellman Keys, EC Diffie Hellman Keys, TLS Premaster Secret, TLS Master Secret, HTTPS/TLS Server/Host Key, HTTPS/TLS Session Integrity Key, and HTTPS/TLS Session Encryption Key, DRBG v and key values, DRBG Output, DRBG Seed, NDRNG Output String, TLS Server Signatures

Service	Access	Key/CSP
connect to module remotely using SSH*	WE	Diffie-Hellman Keys, SSH Server/Host Key, SSH Session Authentication Key, SSH Session Encryption Key, DRBG v and key values, DRBG Output, DRBG Seed, NDRNG Output String
authenticate to module	WE	Crypto Officer Password
show system status	N/A	N/A
show FIPS-CC mode enabled/disabled (console/CLI only)	N/A	N/A
enable FIPS-CC mode of operation (console only)	WE	Configuration Integrity Key
key zeroization	W	All Keys
execute factory reset (disable FIPS-CC mode, console/CLI only)	W	N/A
execute FIPS-CC on-demand self-tests (console only)	E	Configuration Integrity Key, Firmware Integrity Key
add/delete crypto officers and network users	WE	Crypto Officer Password, Network User Password
set/reset crypto officers and network user passwords	WE	Crypto Officer Password, Network User Password
backup/restore configuration file	RWE	Configuration Encryption Key, Configuration Backup Key
read/set/delete/modify module configuration*	N/A	N/A
execute firmware update	WE	Firmware Update Key
read log data	N/A	N/A
delete log data (console/CLI only)	N/A	N/A
execute system diagnostics (console/CLI only)	N/A	N/A
enable/disable alternating bypass mode	N/A	N/A
read/set/delete/modify IPsec/SSL VPN configuration*	W	IPsec: IPsec Manual Authentication Key, IPsec Manual Encryption Key, IKE Pre-Shared Key, IKE RSA Key, IKE ECDSA Key, Diffie-Hellman Keys, EC Diffie-Hellman Keys SSL: HTTPS/TLS Server/Host Key, HTTPS/TLS Session Integrity Key, HTTPS/TLS Session Encryption Key
read/set/modify HA configuration	WE	HA Password, HA Encryption Key

Service	Access	Key/CSP
log offloading to remote FortiAnalyzer device*	E	OFTP Client Key, Diffie-Hellman Keys, EC Diffie-Hellman Keys, TLS Premaster Secret, TLS Master Secret, HTTPS/TLS Session Integrity Key, HTTPS/TLS Session Encryption Key, HTTPS/TLS Server/Host Key, DRBG v and key values, DRBG Output, DRBG Seed, NDRNG Output String
generate CSR with RSA or ECDSA	WE	RSA keys, ECDSA keys

Table 14: Services available to Network Users in FIPS-CC mode

Service/CSP	Access	Key/CSP
connect to module remotely using TLS*	WE	Diffie-Hellman Keys, EC Diffie-Hellman Keys, TLS Premaster Secret, TLS Master Secret, HTTPS/TLS Server/Host Key, HTTPS/TLS Session Integrity Key, HTTPS/TLS Session Encryption Key, DRBG v and key values, DRBG Output, DRBG Seed, NDRNG Output String, TLS Server Signatures
authenticate to module	WE	Network User Password
IPsec VPN controlled by firewall policies*	E	IPsec: IPsec Manual Authentication Key, IPsec Manual Encryption Key, IPsec Session Authentication Key, IPsec Session Encryption Key, IKE Pre-Shared Key, IKE RSA Key, IKE ECDSA Key, IKE SKEYSEED, IKE Authentication Key, IKE Key Generation Key, IKE Session Encryption Key, Diffie-Hellman Keys, EC Diffie-Hellman Keys
SSL VPN controlled by firewall policies*	E	Network User Password, Diffie-Hellman Keys, EC Diffie-Hellman Keys, TLS Premaster Secret, TLS Master Secret, HTTPS/TLS Server/Host Key, HTTPS/TLS Session Integrity Key, HTTPS/TLS Session Encryption Key, DRBG v and key values, DRBG Output, DRBG Seed, NDRNG Output String

Non-FIPS Approved Services

The module also provides the following non-FIPS approved services:

- Configuration backups using password protection
- L2TP and PPTP VPN
- Services marked with an asterisk (*) in Tables 13 and 14 are considered non-approved when using the following

algorithms:

- Non-compliant-strength Diffie-Hellman

The above services shall not be used in the FIPS approved mode of operation.

Authentication

The module implements identity based authentication. Crypto Officers must authenticate with a user-id and password combination to access the modules remotely or locally via the console. Remote Crypto Officer authentication is done over HTTPS (TLS) or SSH. The password entry feedback mechanism does not provide information that could be used to guess or determine the authentication data.

Authentication at level 3 is only applicable when identity-based authentication is enforced for the User role.

By default, Network User access to the modules is based on firewall policy and authentication by IP address or fully qualified domain names. Network Users can optionally be forced to authenticate to the modules using a username/password combination to enable use of the IPsec VPN encrypt/decrypt or bypass services. For Network Users invoking the SSL-VPN encrypt/decrypt services, the modules support authentication with a user-id/password combination. Network User authentication is done over HTTPS and does not allow access to the modules for administrative purposes.

The minimum password length is 8 characters when in FIPS-CC mode (maximum password length is 32 characters) chosen from the set of ninety four (94) characters. New passwords are required to include 1 uppercase character, 1 lowercase character, 1 numeric character, and 1 special character. The odds of guessing a password are 1 in 3,346,172,314,938,369 which is significantly lower than one in a million.

Note that Crypto Officer authentication over HTTPS/SSH and Network User authentication over HTTPS are subject to a limit of 3 failed authentication attempts in 1 minute; thus, the maximum number of attempts in one minute is 3. Therefore the probability of a success with multiple consecutive attempts in a one-minute period is 3 in 3,346,172,314,938,369 which is less than 1/100,000.

Crypto Officer authentication using the console is not subject to a failed authentication limit, but the number of authentication attempts per minute is limited by the bandwidth available over the serial connection which is a maximum of 115,200 bps which is 6,912,000 bits per minute. An 8 byte password would have 64 bits, so there would be no more than 108,000 passwords attempts per minute. Therefore the probability of success would be $1 / (3,346,172,314,938,369 / 108,000)$ which is less than 1/100,000.

For Network Users invoking the IPsec VPN encrypt/decrypt services, the module acts on behalf of the Network User and negotiates a VPN connection with a remote module. The strength of authentication for IPsec services is based on the authentication method defined in the specific firewall policy: IPsec manual authentication key, IKE pre-shared key, IKE RSA key (RSA certificate) or IKE ECDSA key (ECDSA certificate). The odds of guessing the authentication key for each IPsec method is:

- 1 in 16^{40} for the IPsec Manual Authentication key (based on a 40 digit, hexadecimal key)
- 1 in 94^8 for the IKE Pre-shared Key (based on an 8 character, ASCII printable key)
- 1 in 2^{112} for the IKE RSA Key (based on a 2048 bit RSA key size)
- 1 in 2^{128} for the IKE ECDSA Key (based on a P-256 curve ECDSA key size)

A gigabit ethernet connection is 1,048,576,000 bits per second which is 62,914,560,000 bits per minute. An 8-byte key would have 64 bits, so there could be no more than 983,040,000 password attempts per minute. Therefore, the minimum odds of guessing the IKE Preshared key for IPsec within a one-minute period is 1 in $94^8 / 983,040,000$ which is less than 1 in 100,000. Similarly, for the IPsec Manual Authentication key, the minimum odds of Network Users guessing the key within a minute would be 1 in $16^{40} / 393,216,000$. Guessing

the IKE RSA key within a minute would be 1 in $2^{112/561,737,143}$. Guessing the IKE ECDSA key within a minute would be 1 in $2^{128/491,520,000}$.

Physical Security

The modules meet FIPS 140-2 Security Level 2 requirements by using production grade components and an opaque, sealed enclosure. Access to the enclosure is restricted through the use of tamper-evident seals to secure the overall enclosure. The tamper-evident seals shall be installed for the module to operate in a FIPS Approved mode of operation. All Networking devices need tamper-evident seals to meet the FIPS 140-2 Level 2 Physical Security requirements.

The seals are red wax/plastic with black lettering that reads "Fortinet Security Seal".

The tamper seals are not applied at the factory prior to shipping. It is the responsibility of the Crypto Officer to apply the seals before use to ensure full FIPS 140-2 compliance. Once the seals have been applied, the Crypto Officer must develop an inspection schedule to verify that the external enclosure of the modules and the tamper seals have not been damaged or tampered with in any way. Upon viewing any signs of tampering, the Crypto Officer must assume that the device has been fully compromised. The Crypto Officer is required to zeroize the cryptographic module by following the steps in the Key Zeroization section of the SP.

The Crypto Officer is responsible for securing and controlling any unused seals. The Crypto Office is also responsible for the direct control and observation of any changes to the modules such as reconfigurations where the tamper-evident seals are removed or installed to ensure the security of the module is maintained during such changes and ensuring the module is returned to a FIPS approved state.

The surfaces should be cleaned with 99% Isopropyl alcohol to remove dirt and oil before applying the seals. Ensure the surface is completely clean and dry before applying the seals. If a seal needs to be re-applied, completely remove the old seal and clean the surface with an adhesive remover before following the instructions for applying a new seal.

Additional seals can be requested through your Fortinet sales contact. Reference the 'FIPS-SEAL-RED' SKU when ordering. Specify the number of seals required based on the specific model as described below:

The FortiGate-5001D uses 19 seals to secure the external enclosure:

- the front panel cooling fan bay cover (2 seals, see Figures 9, 10 and 11)
- the front panel NMI and Factory Use switches (1 seal, see Figure 11)
- the front panel blades and blank face plates (7 seals, see Figure 11)
- the rear panel blank face plates (7 seals, see Figure 12)
- the top panel fan trays (2 seals, see Figure 13)

The FortiGate-600D uses one seal to secure the external enclosure (see Figure 14).

The FortiGate-1200D and 1500D use three seals to secure the power supplies and the external enclosure (see Figure 15 and Figure 16).

The FortiGate-3000D uses three seals to secure the external enclosure (see Figure 17 and Figure 18).

The FortiGate-3700D uses three seals to secure the external enclosure and power supplies (see Figure 19 and Figure 20).

Figure 10 - FortiGate-5001D seals, left side view

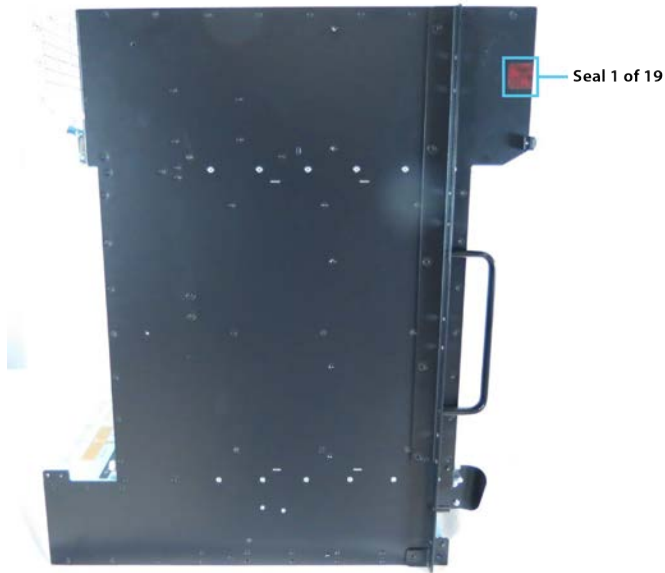

Figure 11 - FortiGate-5001D seals, right side view

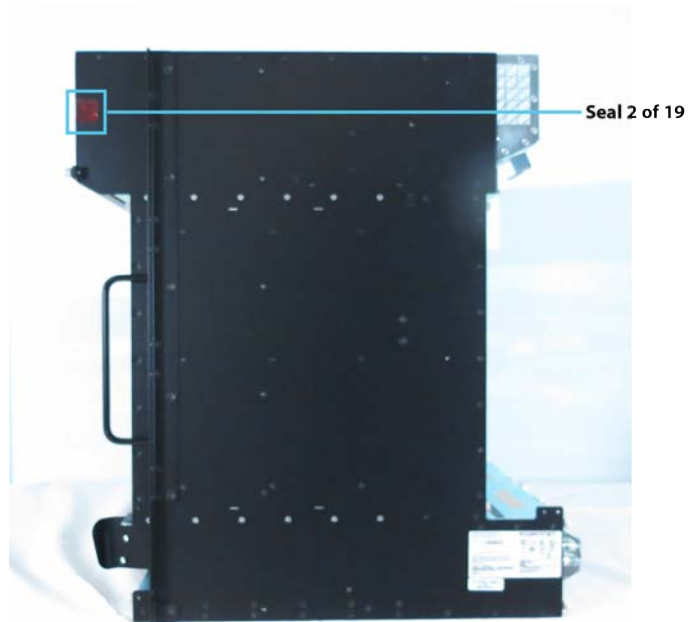

Figure 12 - FortiGate-5001D seals, front view

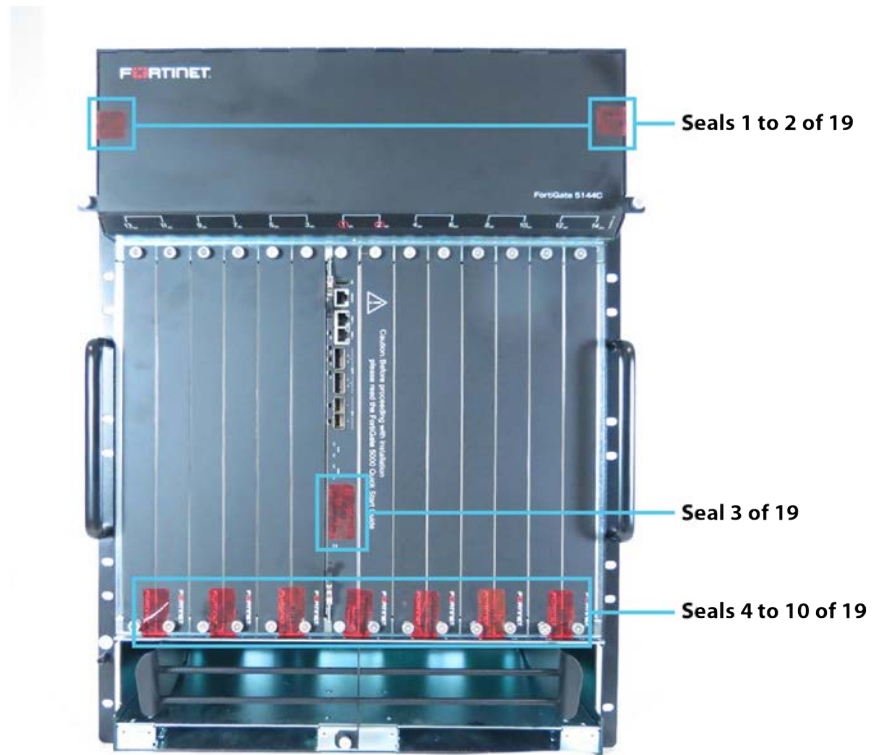

Figure 13 - FortiGate-5001D seals, rear view



Figure 14 - FortiGate-5001D seals, top view

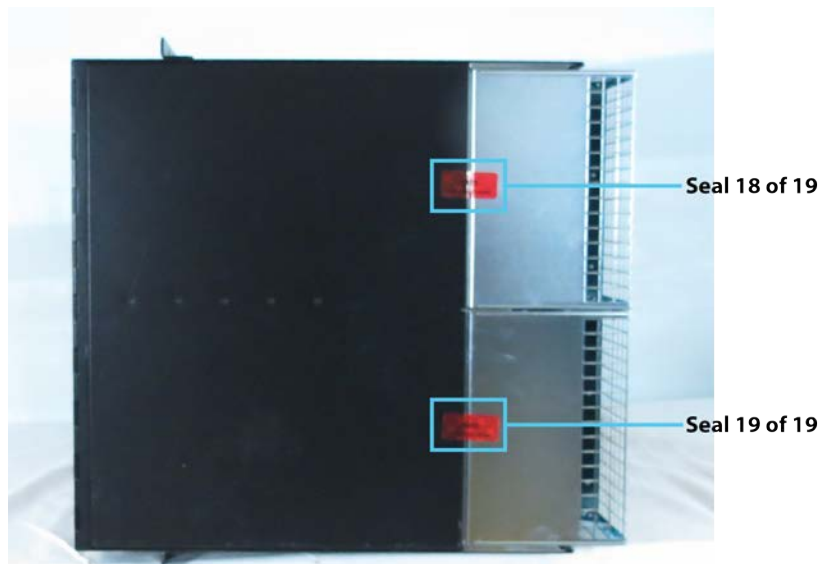

Figure 15 - FortiGate-600D external enclosure seal, top, rear

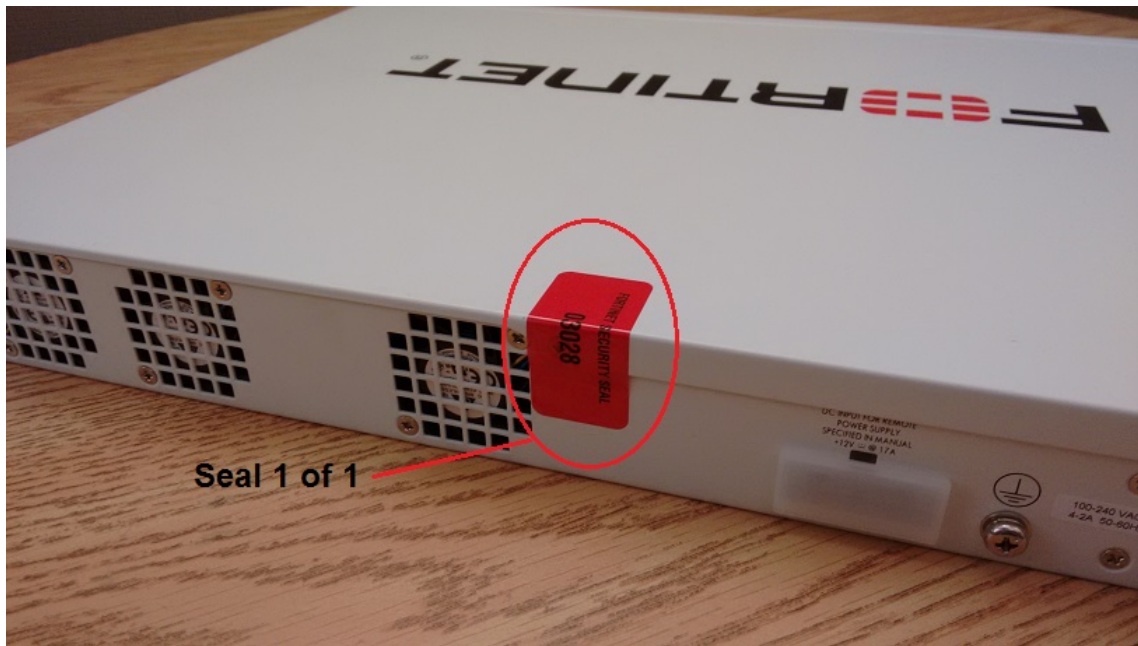

Figure 16 - FortiGate-1200D and 1500D power supply seals. bottom, rear

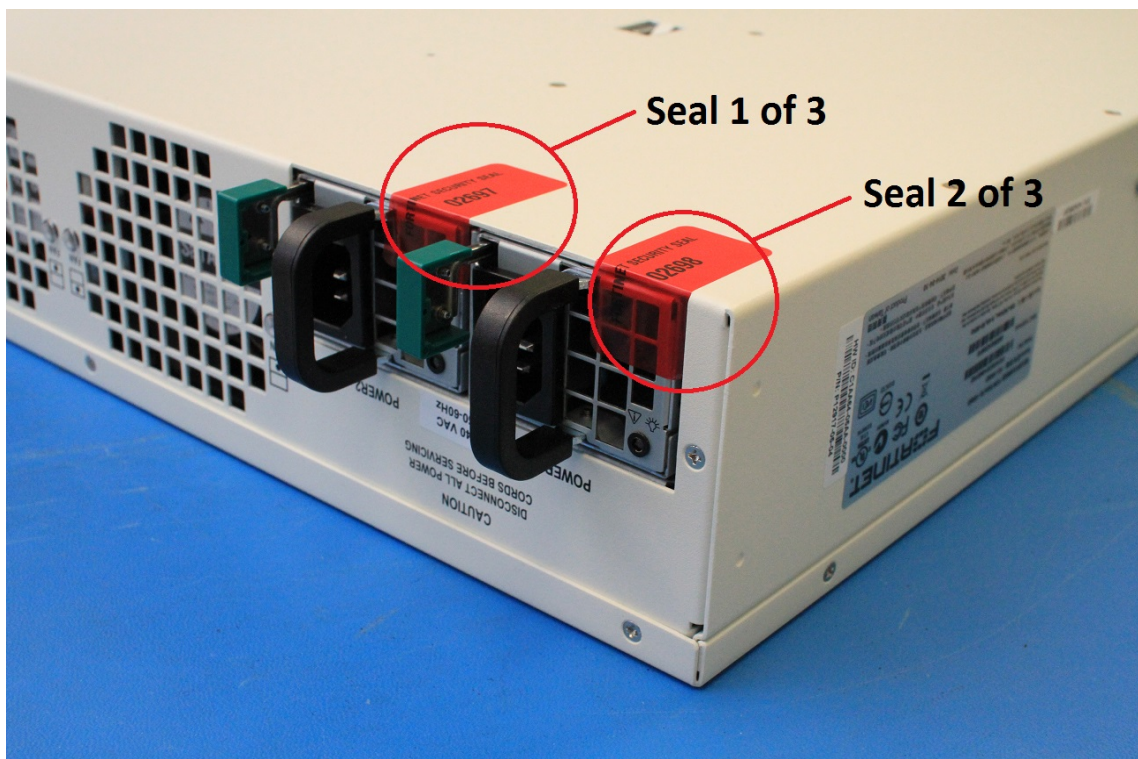

Figure 17 - FortiGate-1200D and 1500D external enclosure seal, top, left side

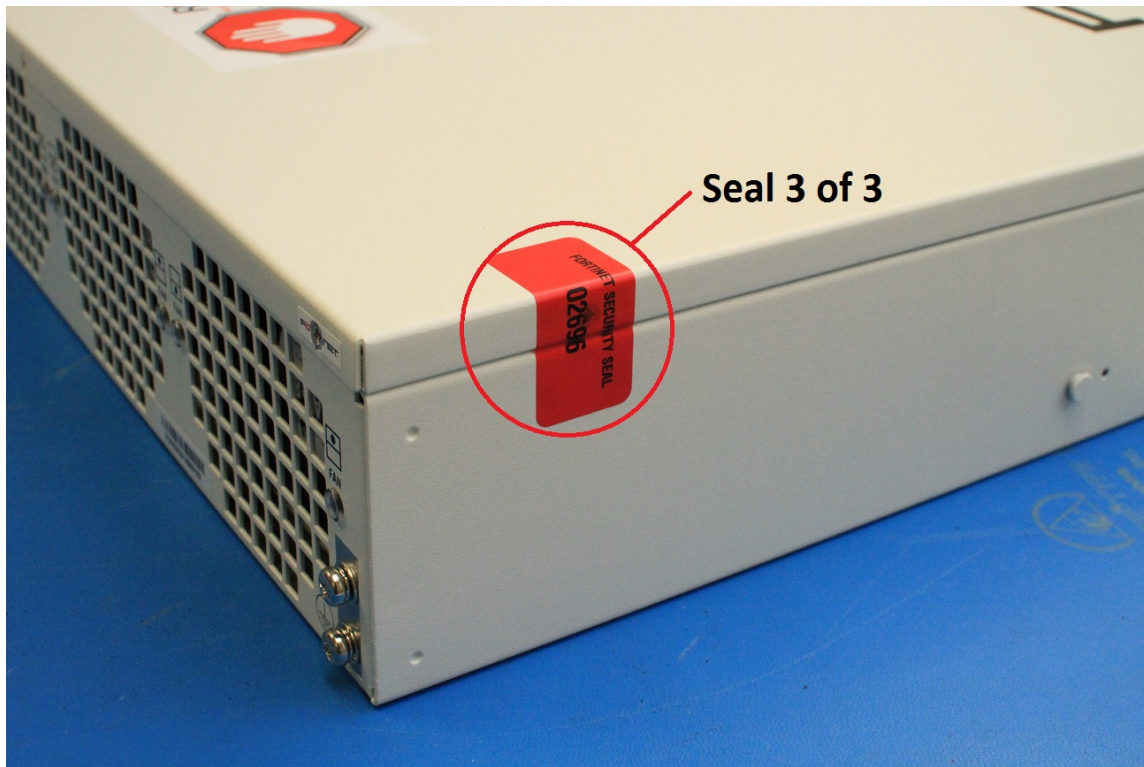

Figure 18 - FortiGate-3000D external enclosure seals, rear, bottom

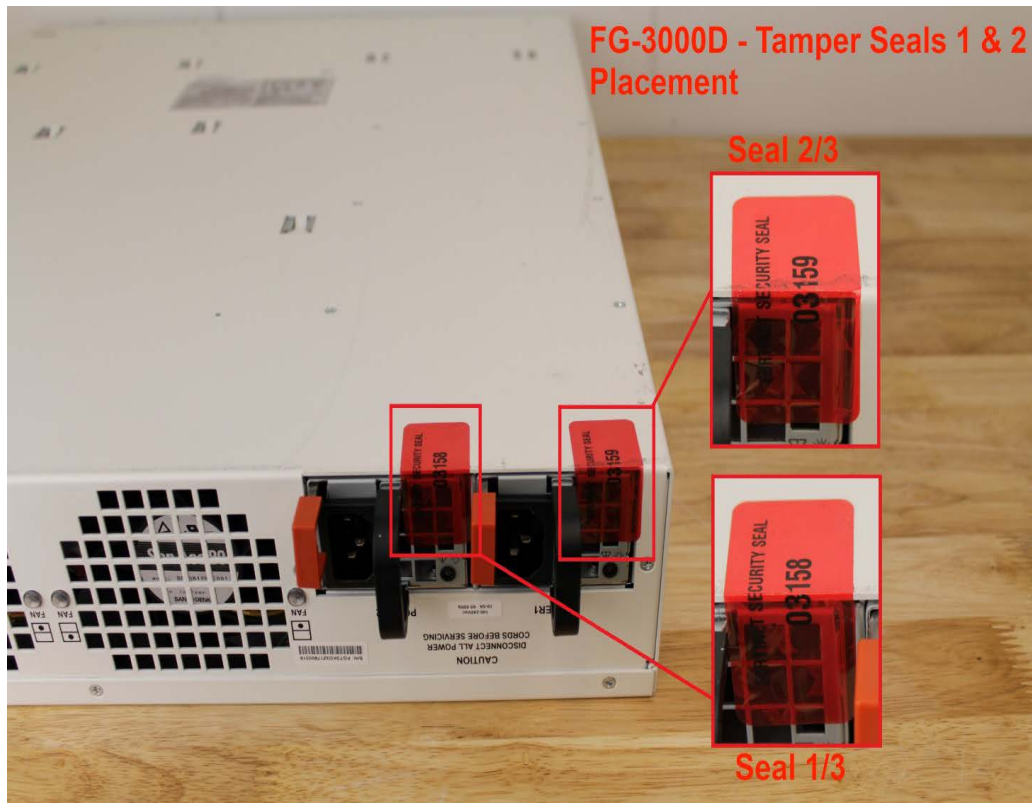

Figure 19 - FortiGate-3000D external enclosure seal, top, left side



Figure 20 - FortiGate-3700D external enclosure seal and power supply seal, right, rear

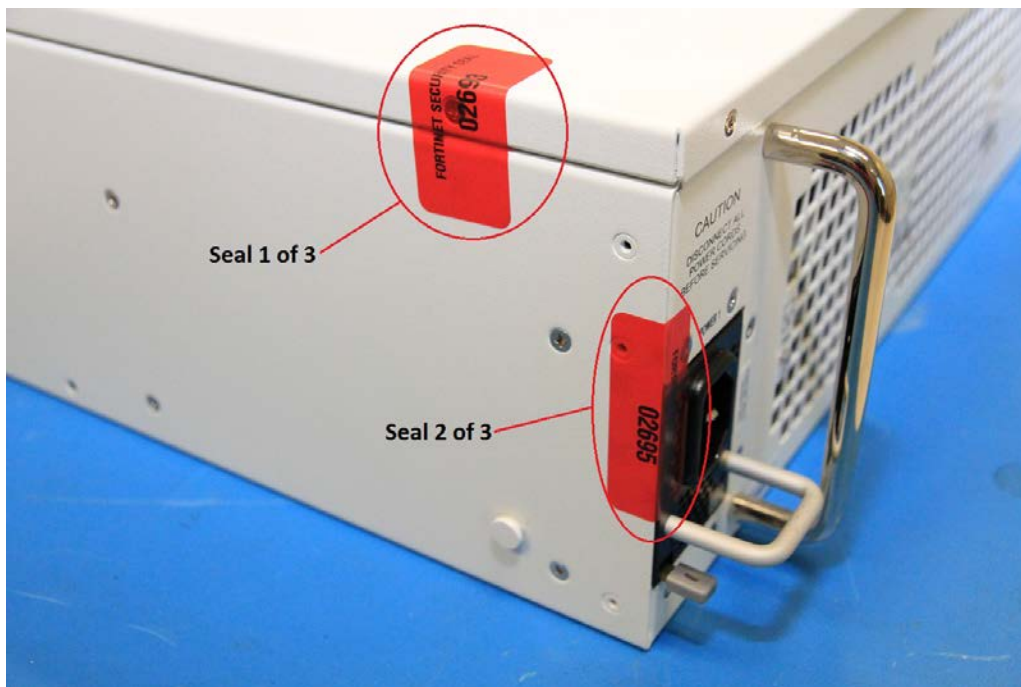
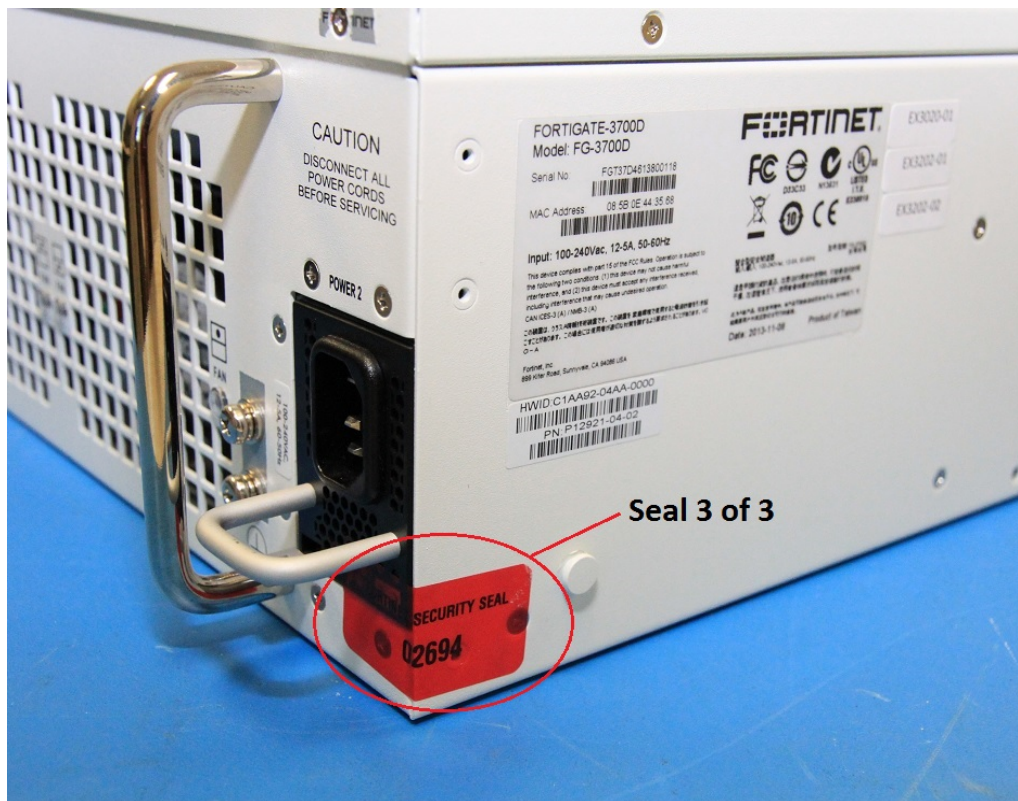

Figure 21 - FortiGate-3700D power supply seal, rear, left

Operational Environment

The modules consist of the combination of the FortiOS operating system and the FortiGate appliances. The FortiOS operating system can only be installed, and run, on a FortiGate appliance. The FortiOS operating system provides a proprietary and non-modifiable operating system.

Cryptographic Key Management

Random Number Generation

The modules use a firmware based, deterministic random bit generator (DRBG) that conforms to NIST Special Publication 800-90A.

Entropy

The module uses an entropy token (Araneus Alea II) to seed the DRBG during the modules' boot process and to periodically reseed the DRBG. The entropy token is not included in the boundary of the module and therefore no assurance can be made for the correct operation of the entropy token nor is there a guarantee of stated entropy.

Entropy Strength

The entropy loaded into the approved AES-256 bit DRBG is 256 bits. The entropy source is over-seeded and then an HMAC-SHA-256 post-conditioning component (as per section 6.4.2 of SP 800-90B) is applied.

Reseed Period

The RBG is seeded from the Entropy Token during the boot process and then reseeded periodically. The default reseed period is once every 24 hours (1440 minutes) and is configurable (1 to 1440 minutes). The entropy token must be installed to complete the boot process and to reseed the main PCB DRBG instance.

Key Zeroization

The zeroization process must be performed under the direct control of the operator. The operator must be present to observe that the zeroization method has completed successfully.

All keys and CSPs are zeroized by erasing the module's boot device and then power cycling the FortiGate unit. To erase the boot device, execute the following command from the CLI:

```
execute erase-disk <boot device>
```

The boot device ID may vary depending on the FortiGate module. Executing the following command will output a list of the available internal disks:

```
execute erase-disk ?
```

Algorithms

Table 15: FIPS approved algorithms

Algorithm	NIST Cert Number
CTR DRBG (NIST SP 800-90A) with AES 256 bits	C1571, C1573
AES in CBC mode (128, 192, and 256 bits) (192 bits for C1797 only)	C1548, C1549, C1572, C1575, C1797
AES in GCM mode (128, 256 bits)	C1572, C1574, C1575, C1576
SHA-1	C1572, C1574, C1575, C1576, C1797
SHA-224	A1186, A1187
SHA-256	C1572, C1574, C1575, C1576, C1797
SHA-384	C1572, C1574, C1575, C1576, C1797
SHA-512	C1572, C1574, C1575, C1576, C1797
HMAC SHA-1	C1572, C1574, C1575, C1576, C1797
HMAC SHA-256	C1572, C1574, C1575, C1576, C1797
HMAC SHA-384	C1572, C1574, C1575, C1576
HMAC SHA-512	C1572, C1574, C1575, C1576

Algorithm	NIST Cert Number
RSA PKCS 1.5 Key Pair Generation: 2048 and 3072-bit (** C1574, C1576, and C1797 only) Signature Generation: 2048 and 3072-bit (** C1797 only includes 2048 bit) Signature Verification: 1024, 2048 and 3072-bit For legacy use, the module supports 1024-bit RSA keys and SHA-1 for signature verification	C1574, C1576, C1797, A1252, A1293
RSA PSS Signature Generation: 2048 and 3072-bit Signature Verification: 1024, 2048 and 3072-bit	A1186, A1187
ECDSA Key Pair Generation: curve P-256	C1572, C1574, C1575, C1576
ECDSA Key Pair Generation: curve P-384	C1572, C1575
ECDSA Key Pair Generation: curve P-521	C1572, C1574, C1575, C1576
ECDSA Signature Generation: curves P-256, P-384 and P-521	C1572, C1574, C1575, C1576
ECDSA Signature Verification: curves P-256, P-384 and P-521	C1572, C1574, C1575, C1576
CVL (KDF SSH) - AES 128 bit-, AES 256 bit -CBC (using SHA1, SHA-256)	C1574, C1576
CVL (KDF TLS 1.1 and 1.2 (using SHA-256, SHA-384))	C1574, C1576
CVL (KDF IKE v1 (using SHA2-256))	C1572
CVL (KDF IKE v1 (using SHA-1, SHA2-256, SHA2-384, SHA2-512))	C1575
CVL (KDF IKE v2 (using SHA2-512))	C1572
CVL (KDF IKE v2 (using SHA-1, SHA2-256, SHA2-384, SHA2-512))	C1575

Algorithm	NIST Cert Number
CVL (ECDSA SigGen Component: Curves P-256, P-384 and P-521)	C1572, C1574, C1575, C1576
CVL (KAS-FFC Component) - FB: SHA2-256 FC: SHA2-256	C1572, C1574, C1575, C1576
CVL (KAS-ECC Component) - EC: SHA2-256, Curve: P-256 ED: SHA2-384, Curve: P-384 EE: SHA2-512, Curve: P-521	C1572, C1574, C1575, C1576
CVL (KDF SNMP) - Password length: 64 - 128	C1574, C1576

KTS (AES Certs. #C1548 and #C1549 and HMAC Certs. #C1574 and #C1576; key establishment methodology provides 128 or 256 bits of encryption strength); and

KTS (AES Certs. #C1574 and #C1576; key establishment methodology provides 128 or 256 bits of encryption strength)

For AES GCM IPsec/IKEv2, RFC 7296 is used to establish the shared secret SKEYSEED from which the AES GCM

encryption keys are derived

Table 16: FIPS allowed algorithms

Algorithm
Diffie-Hellman (CVL Certs. #C1572, #C1574, C1575 and #C1576 , key agreement; key establishment methodology provides between 112 and 196 bits of encryption strength)
EC Diffie-Hellman (CVL Certs. #C1572, #C1574, C1575 and #C1576 , key agreement; key establishment methodology provides between 128 and 256 bits of encryption strength)
NDRNG (Araneus Alea II entropy token is not part of the validation)

Table 17: Non-FIPS approved algorithms

Algorithm
Diffie-Hellman is non-compliant when keys less than 2048 bits are used, since such keys do not provide the minimum required 112 bits of encryption strength.
4096-bit RSA signature generation is non-compliant.
The following ECC curves shall not be used in the Approved mode of operation: brainpoolP224r1, brainpoolP256r1, brainpoolP384r1, brainpoolP512r1, Curve25519 and Curve448.

Note that the IKE, SSH, SNMP, and TLS protocols, other than the KDF, have not been tested by the CMVP or CAVP as per FIPS 140-2 Implementation Guidance D.11.

The module is compliant to IG A.5: GCM is used in the context of TLS and IKEv2/IPSec.

For TLS, The GCM implementation meets Option 1 of IG A.5: it is used in a manner compliant with SP 800-52 and in accordance with RFC 5246 for TLS key establishment. The AES GCM IV generation is in compliance with RFC 5288 and shall only be used for the TLS protocol version 1.2 to be compliant with FIPS140-2 IG A.5,

Option 1 (“TLS protocol IV generation”); thus, those cipher suites implemented in the module that utilize AES-GCM are consistent with those specified in Section 3.3.1.1.2 of [SP800-52, Rev2]. During operational testing, the module was tested against an independent version of TLS and found to behave correctly.

For IPsec/IKEv2, the GCM implementation meets Option 1 of IG A.5: it is used in a manner compliant with RFCs 4106 and 7296. During operational testing, the module was tested against an independent version of IPsec with IKEv2 and found to behave correctly.

In case the module’s power is lost and then restored, the key used for the AES GCM encryption or decryption shall be re-distributed.

There are algorithms, modes, and keys that have been CAVs tested but are not used by the module. Only the algorithms, modes/methods, and key lengths/curves/moduli shown in the above tables are used by the module.

Cryptographic Keys and Critical Security Parameters

The following table lists all of the cryptographic keys and critical security parameters used by the modules. The following definitions apply to the table.

Table 18: Cryptographic Keys and Critical Security Parameters used in FIPS-CC mode

Key or CSP	Generation	Storage	Usage	Zeroization
NDRNG output string	NDRNG	Boot device Plain-text	Input string for the entropy pool	By erasing the Boot device and power cycling the module
DRBG seed	Internally generated	SDRAM Plain-text	256 bit seed used by the DRBG (output from NDRNG)	By erasing the Boot device and power cycling the module
DRBG output	Internally generated	SDRAM Plain-text	Random numbers used in cryptographic algorithms (256 bits)	By erasing the Boot device and power cycling the module
DRBG v and key values	Internally generated	SDRAM Plain-text	Internal state values for the DRBG 128 and 256	By erasing the Boot device and power cycling the module
IPsec Manual Authentication Key	Electronic key entry	Boot device AES encrypted	Used as IPsec Session Authentication Key	By erasing the Boot device and power cycling the module
IPsec Manual Encryption Key	Electronic key entry	SDRAM Plain-text	Used as IPsec Session Encryption Key using AES (128, 256 bit)	By erasing the Boot device and power cycling the module

Key or CSP	Generation	Storage	Usage	Zeroization
IPsec Session Authentication Key	Internally generated using DRBG	SDRAM Plain-text	IPsec peer-to-peer authentication using HMAC SHA-1 or HMAC SHA-256	By erasing the Boot device and power cycling the module
IPsec Session Encryption Key	Internally generated via DH or ECDH KAS	SDRAM Plain-text	VPN traffic encryption/decryption using AES (128, 256 bit)	By erasing the Boot device and power cycling the module
IKE SKEYSEED	Derived via KDF defined in SP800-135 (IKEv2)	SDRAM Plain-text	Used to generate IKE protocol keys	By erasing the Boot device and power cycling the module
IKE Pre-Shared Key	Electronic key entry	Boot device AES encrypted	Used to generate IKE protocol keys	By erasing the Boot device and power cycling the module
IKE Authentication Key	Internally generated using DRBG	SDRAM Plain-text	IKE peer-to-peer authentication using HMAC SHA-1, -256, -384 or -512	By erasing the boot device and power cycling the module
IKE Key Generation Key	Internally generated using DRBG	SDRAM Plain-text	IPsec SA keying material	By erasing the boot device and power cycling the module
IKE Session Encryption Key	Internally generated via DH or ECDH KAS	SDRAM Plain-text	Encryption of IKE peer-to-peer key negotiation using or AES (128, 256 bit)	By erasing the boot device and power cycling the module
IKE RSA Key	Externally generated	Boot device Plain-text	RSA private key used in the IKE protocol (2048 and 3072 bit signatures)	By erasing the boot device and power cycling the module
IKE ECDSA Key	Externally generated	Boot device Plain-text	ECDSA private key used in the IKE protocol (signatures using P-256, P-384 and P-521 curves)	By erasing the boot device and power cycling the module
Diffie-Hellman Keys	Internally generated using DRBG	SDRAM Plain-text	Key agreement and key establishment (Public key size of 2048 to 8192 bits with Private key size of 224 to 400 bits)	By erasing the boot device and power cycling the module

Key or CSP	Generation	Storage	Usage	Zeroization
EC Diffie-Hellman Keys	Internally generated using DRBG	SDRAM Plain-text	Key agreement and key establishment (key pairs on the curves secp256r1, secp384r1 and secp521r1)	By erasing the boot device and power cycling the module
Firmware Update Key	Preconfigured	Boot device Plain-text	Verification of firmware integrity when updating to new firmware versions using RSA public key (firmware load test, 2048 bit signature)	By erasing the boot device and power cycling the module
Firmware Integrity Key	Preconfigured	Boot device Plain-text	Verification of firmware integrity in the firmware integrity test using RSA public key (firmware integrity test, 2048 bit signature)	By erasing the boot device and power cycling the module
TLS Premaster Secret	Internally generated via DH or ECDH KAS	SDRAM Plain-text	HTTPS/TLS keying material	By erasing the boot device and power cycling the module
TLS Master Secret	Internally generated from the TLS Premaster Secret	SDRAM Plain-text	384 bit master key used in the HTTPS/TLS protocols	By erasing the boot device and power cycling the module
HTTPS/TLS Server/Host Key	Preconfigured	Boot device Plain-text	RSA private key used in the HTTPS/TLS protocols (key establishment, 2048 or 3072 bit)	By erasing the boot device and power cycling the module
HTTPS/TLS Session Integrity Key	Internally generated using DRBG	SDRAM Plain-text	HMAC SHA-1, -256 or -384 key used for HTTPS/TLS session integrity	By erasing the boot device and power cycling the module
TLS Server Signatures	Preconfigured	Boot device Plain-text	rsa_pkcs1 & rsa_pss_rsae signatures used in TLS	By erasing the boot device and power cycling the module

Key or CSP	Generation	Storage	Usage	Zeroization
HTTPS/TLS Session Encryption Key	Internally generated via DH or ECDH KAS	SDRAM Plain-text	AES (128, 256 bit) key used for HTTPS/TLS session encryption	By erasing the boot device and power cycling the module
SSH Server/Host Key	Preconfigured	Boot device Plain-text	RSA private key used in the SSH protocol (key establishment, 2048 or 3072 bit)	By erasing the boot device and power cycling the module
SSH Session Authentication Key	Internally generated using DRBG	SDRAM Plain-text	HMAC SHA-1 or HMAC SHA-256 key used for SSH session authentication	By erasing the boot device and power cycling the module
SSH Session Encryption Key	Internally generated via DH or ECDH KAS	SDRAM Plain-text	AES (128, 256 bit) key used for SSH session encryption	By erasing the boot device and power cycling the module
Crypto Officer Password	Electronic key entry	Boot device SHA-1 hash	Used to authenticate operator access to the module	By erasing the boot device and power cycling the module
Configuration Integrity Key	Preconfigured	Boot device Plain-text	HMAC SHA-256 hash used for configuration bypass test	By erasing the boot device and power cycling the module
Configuration Encryption Key	Preconfigured	Boot device Plain-text	AES 256 bit key used to encrypt CSPs on the Boot device and in the backup configuration file (except for crypto officer passwords in the backup configuration file)	By erasing the boot device and power cycling the module
Configuration Backup Key	Preconfigured	Boot device Plain-text	HMAC-SHA-256 key used to hash crypto officer passwords in the backup configuration file	By erasing the boot device and power cycling the unit
Network User Password	Electronic key entry	Boot device SHA-1 hash	Used to authenticate network access to the module	By erasing the boot device and power cycling the unit

Key or CSP	Generation	Storage	Usage	Zeroization
HA Password	Electronic key entry	Boot device AES encrypted	Used to authenticate FortiGate units in an HA cluster	By erasing the boot device and power cycling the unit
HA Encryption Key	Externally generated	Boot device AES encrypted	Encryption of traffic between units in an HA cluster using AES 128 bit key	By erasing the boot device and power cycling the unit
OFTP Client Key	Externally generated	Boot device Plain-text	RSA private key used in the OFTP/TLS protocol (key establishment, 2048 bit signature)	By erasing the boot device and power cycling the module
RSA Keys	Internally generated using DRBG	Boot device Plain-text	RSA Key Pair from RSA CSR generation	By erasing the boot device and power cycling the module
ECDSA Keys	Internally generated using DRBG	Boot device Plain-text	ECDSA Key Pair from ECDSA CSR generation	By erasing the boot device and power cycling the module



The Generation column lists all of the keys/CSPs and their entry/generation methods. Electronically entered keys are entered by the operator electronically (as defined by FIPS) using the console or a management computer. Pre-configured keys are set as part of the firmware (hardcoded) and are not operator modifiable.

Externally generated keys are generated outside the module and loaded by the operator electronically and are not compliant with SP 800-133 unless they were generated by another FIPS validated module.

Alternating Bypass Feature

The primary cryptographic function of the module is as a firewall and VPN device. The module implements two forms of alternating bypass for VPN traffic: policy based (for IPsec and SSL VPN) and interface based (for IPsec VPN only).

Policy Based VPN

Firewall policies with an action of IPsec or SSL-VPN mean that the firewall is functioning as a VPN start/end point for the specified source/destination addresses and will encrypt/decrypt traffic according to the policy. Firewall policies with an action of allow mean that the firewall is accepting/sending plaintext data for the specified source/destination addresses.

A firewall policy with an action of accept means that the module is operating in a bypass state for that policy. A firewall policy with an action of IPsec or SSL-VPN means that the module is operating in a non-bypass state for that policy.

Interface Based VPN

Interface based VPN is supported for IPsec only. A virtual interface is created and any traffic routed to the virtual interface is encrypted and sent to the VPN peer. Traffic received from the peer is decrypted. Traffic through the virtual interface is controlled using firewall policies. However, unlike policy based VPN, the action is restricted to Accept or Deny and all traffic controlled by the policy is encrypted/decrypted.

When traffic is routed over the non-virtual interface, the module is operating in a bypass state. When traffic is routed over the virtual interface, the module is operating in a non-bypass state.

In both cases, two independent internal actions must be taken to create a bypass firewall policies.

Key Archiving

The module supports key archiving to a management computer as part of the module configuration file backup. Operator entered keys are archived as part of the module configuration file. The configuration file is stored in plain text, but keys in the configuration file are either AES encrypted using the Configuration Encryption Key or stored as a keyed hash using HMAC SHA-256 using the Configuration Backup Key.

Mitigation of Other Attacks

The module includes a real-time Intrusion Prevention System (IPS) as well as antivirus protection, web content filtering, DNS filtering, application control and data leak prevention. Use of these capabilities is optional.

The FortiOS IPS has two components: a signature based component for detecting attacks passing through the FortiGate appliance and a local attack detection component that protects the firewall from direct attacks. Functionally, signatures are similar to virus definitions, with each signature designed to detect a particular type of attack. The IPS signatures are updated through the FortiGuard IPS service. The IPS engine can also be updated through the FortiGuard IPS service.

FortiOS antivirus protection removes and optionally quarantines files infected by viruses from web (HTTP), file transfer (FTP), and email (POP3, IMAP, and SMTP) content as it passes through the FortiGate modules. FortiOS antivirus protection also controls the blocking of oversized files and supports blocking by file extension. Virus signatures are updated through the FortiGuard antivirus service. The antivirus engine can also be updated through the FortiGuard antivirus service.

FortiOS antispam protection tags (SMTP, IMAP, POP3) or discards (SMTP only) email messages determined to be spam. Multiple spam detection methods are supported including the FortiGuard managed antispam service.

FortiOS web filtering can be configured to provide web (HTTP) content filtering. FortiOS web filtering uses methods such as banned words, address block/exempt lists, and the FortiGuard managed content service.

FortiOS DNS filtering can be configured to provide web content (HTTP/HTTPS) content filtering based on DNS domain lookup. FortiOS DNS filtering uses the FortiGuard DNS database.

FortiOS application control can detect and take action against network traffic depending on the application generating the traffic. FortiOS application control uses the FortiGuard application control database.

FortiOS data leak prevention is used to prevent sensitive data from leaving your network. After sensitive data patterns are defined, data matching the patterns will either be blocked or logged and then allowed.

Whenever a IPS, antivirus, or other filtering event occurs, the modules can record the event in the log and/or send an alert email to an operator.

For complete information refer to the FortiGate Installation Guide for the specific module in question, the FortiGate Administration Guide and the FortiGate IPS Guide.

Electromagnetic Interference/Electromagnetic Compatibility (EMI/EMC)

The modules comply with EMI/EMC requirements for Class A devices as specified by Part 15, Subpart B, of the FCC rules. The following table lists the specific lab and report information for the modules.

FCC Report Information

Module	Lab Information	FCC Report Number
FG-5001D	Bay Area Compliance Laboratories Corp. 1274 Anvilwood Ave. Sunnyvale, CA 94086 (408)-732-9162	R1406092-15
FG-600D	Spectrum Research & Testing Lab., Inc. No. 167, Ln. 780, Shan-Tong Rd., Ling 8, Shan-Tong Li, Chung-Li City, Taoyuan County 320, Taiwan	FCAA14061702-02
FG-1200D	SPORTON International Inc. No. 52, Hwa Ya 1st Rd., Hwa Ya Technology Park, Kwei-shan Dist., Taoyuan City, Taiwan	FV381374-05
FG-1500D	SPORTON International Inc. No. 52, Hwa Ya 1st Rd., Hwa Ya Technology Park, Kwei-shan Dist., Taoyuan City, Taiwan	FV381374-05
FG-3000D	Veritas Consumer Products Services (H.K.) Ltd. No. 19, Hwa Ya 2nd Rd., Hwa Ta Technology Park, Kwei-shan Dist., Taoyuan City, Taiwan	FV141124C09D
FG-3700D	Bay Area Compliance Laboratories Corp. 1274 Anvilwood Ave. Sunnyvale, CA 94086	R1309162-15

FIPS 140-2 Compliant Operation

The Fortinet hardware is shipped in a non-FIPS 140-2 compliant configuration. The following steps must be performed to put the module into a FIPS compliant configuration:

1. Download the model specific FIPS validated firmware image from the Fortinet Support site at <https://support.fortinet.com/>
2. Verify the integrity of the firmware image
3. Install the FIPS validated firmware image
4. Install the entropy token
5. Enable the FIPS-CC mode of operation

These steps are described in detail in the "FIPS 140-2 and Common Criteria Compliant Operation for FortiOS 5.6" document that can be found on the Fortinet Technical Documentation website.

In addition, FIPS 140-2 compliant operation requires both that you use the module in its FIPS-CC mode of operation and that you follow secure procedures for installation and operation of the FortiGate unit. You must ensure that:

- The FortiGate unit is configured in the FIPS-CC mode of operation.
- The FortiGate unit is installed in a secure physical location.
- Physical access to the FortiGate unit is restricted to authorized operators.
- The entropy token remains in the USB port during operation.
- Administrative passwords are at least 8 characters long.
- Administrative passwords are changed regularly.
- Administrator account passwords must have the following characteristics:
 - One (or more) of the characters must be capitalized
 - One (or more) of the characters must be lower case
 - One (or more) of the characters must be numeric
 - One (or more) of the characters must be non alpha-numeric (e.g. punctuation mark)
- Administration of the module is permitted using only validated administrative methods. These are:
 - Console connection
 - Web-based manager via HTTPS
 - Command line interface (CLI) access via SSH
- Diffie-Hellman groups of less than 2048 bits are not used.
- Client side RSA certificates must use 2048 bit or greater key sizes.
- Only approved and allowed algorithms are used.
- IPSec VPN tunnels using AES-GCM should be configured with a key lifetime of 98,000 KB to ensure a rekey after a maximum of 2^{16} encryptions.

The module can be used in either of its two operation modes: NAT/Route or Transparent. NAT/Route mode applies security features between two or more different networks (for example, between a private network and the Internet). Transparent mode applies security features at any point in a network. The current operation mode is displayed on the web-based manager status page and in the output of the `get system status` CLI command.

Once the FIPS validated firmware has been installed and the module properly configured in the FIPS-CC mode of operation, the module is running in a FIPS compliant configuration. It is the responsibility of the CO to ensure the module only uses approved algorithms and services to maintain the module in a FIPS-CC Approved mode of operation. Using any of the non-approved algorithms and services switches the module to a non-FIPS mode of operation. Prior to switching between modes the CO should ensure all keys and CSPs are zeroized to prevent sharing of keys and CSPs between the FIPS Approved and non-FIPS mode of operation.

Enabling FIPS-CC mode

To enable the FIPS 140-2 compliant mode of operation, the operator must execute the following command from the Local Console:

```
config system fips-cc
  set status enable
end
```

The Operator is required to supply a password for the admin account which will be assigned to the Crypto Officer role.

The supplied password must be at least 8 characters long and correctly verified before the system will restart in FIPS-CC mode.

Upon restart, the module will execute self-tests to ensure the correct initialization of the module's cryptographic functions.

After restarting, the Crypto Officer can confirm that the module is running in FIPS-CC mode by executing the following command from the CLI:

```
get system status
```

If the module is running in FIPS-CC mode, the system status output will display the line:

```
FIPS-CC mode: enable
```

Self-Tests

Startup and Initialization Self-tests

The module executes the following self-tests during startup and initialization:

- Firmware integrity test using RSA 2048-bit signatures
- Configuration/VPN bypass test using HMAC SHA-256
- AES (128, 256 bit), CBC mode, encrypt known answer test
- AES (128, 256 bit) CBC mode, decrypt known answer test
- AES (128, 256 bit), GCM mode, encrypt known answer test
- AES (128, 256 bit), GCM mode, decrypt known answer test
- HMAC SHA-1 known answer test
- SHA-1 known answer test (tested as part of HMAC SHA-1 known answer test)
- HMAC SHA-256 known answer test
- SHA-256 known answer test (tested as part of HMAC SHA-256 known answer test)
- HMAC SHA-384 known answer test
- SHA-384 known answer test (tested as part of HMAC SHA-384 known answer test)
- HMAC SHA-512 known answer test
- SHA-512 known answer test (tested as part of HMAC SHA-512 known answer test)
- RSA 2048-bit signature generation known answer test
- RSA 2048-bit signature verification known answer test
- ECDSA pairwise consistency test
- DRBG known answer tests (as per SP 800-90A)
- Primitive-Z known answer test (DH and ECDH)

The results of the startup self-tests are displayed on the console during the startup process.

The startup self-tests can also be initiated on demand using the CLI command `execute fips kat all` (to initiate all self-tests) or `execute fips kat <test>` (to initiate a specific self-test).

When the self-tests are run, each implementation of an algorithm is tested - i.e. when the AES self-test is run, all AES implementations are tested.

Conditional Self-tests

The module executes the following conditional tests when the related service is invoked:

- Continuous NDRNG test
- Continuous DRBG test
- RSA pairwise consistency test
- ECDSA pairwise consistency test

- Configuration/VPN bypass test using HMAC SHA-256
- Firmware load test using RSA 2048-bit signatures

Critical Function Self-tests

The module also performs the following critical function self-tests applicable to the DRBG, as per NIST SP 800-90A Section 11:

- Instantiate test
- Generate test
- Reseed test

Error State

If any of the self-tests or conditional tests fail, the module enters an error state as shown by the console output below:

```
Self-tests failed
Entering error mode...
The system is going down NOW !!
The system is halted.
```

All data output and cryptographic services are inhibited in the error state.



High Performance Network Security

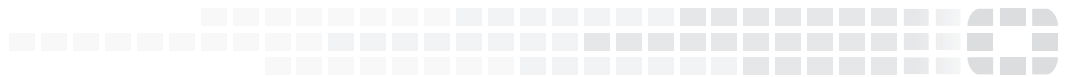

Copyright© 2021 Fortinet, Inc. All rights reserved. Fortinet®, FortiGate®, FortiCare® and FortiGuard®, and certain other marks are registered trademarks of Fortinet, Inc., in the U.S. and other jurisdictions, and other Fortinet names herein may also be registered and/or common law trademarks of Fortinet. All other product or company names may be trademarks of their respective owners. Performance and other metrics contained herein were attained in internal lab tests under ideal conditions, and actual performance and other results may vary. Network variables, different network environments and other conditions may affect performance results. Nothing herein represents any binding commitment by Fortinet, and Fortinet disclaims all warranties, whether express or implied, except to the extent Fortinet enters a binding written contract, signed by Fortinet's General Counsel, with a purchaser that expressly warrants that the identified product will perform according to certain expressly-identified performance metrics and, in such event, only the specific performance metrics expressly identified in such binding written contract shall be binding on Fortinet. For absolute clarity, any such warranty will be limited to performance in the same ideal conditions as in Fortinet's internal lab tests. In no event does Fortinet make any commitment related to future deliverables, features, or development, and circumstances may change such that any forward-looking statements herein are not accurate. Fortinet disclaims in full any covenants, representations, and guarantees pursuant hereto, whether express or implied. Fortinet reserves the right to change, modify, transfer, or otherwise revise this publication without notice, and the most current version of the publication shall be applicable.