



Cisco ASA 5512-X, ASA 5515-X, ASA 5525-X, ASA 5545-X, ASA 5555-X,
ASA 5580-20, ASA 5580-40, ASA 5585-X SSP-10, 5585-X SSP-20, 5585-X
SSP-40 and 5585-X SSP-60 Security Appliances

**FIPS 140-2 Non Proprietary Security Policy
Level 2 Validation**

Version 3.0

August 25, 2016

Table of Contents

1	INTRODUCTION.....	1
1.1	PURPOSE.....	1
1.2	MODULE VALIDATION LEVEL	1
1.3	REFERENCES.....	1
1.4	TERMINOLOGY	2
1.5	DOCUMENT ORGANIZATION	2
2	CISCO ASA 5500 SECURITY APPLIANCES.....	3
2.1	ASA 5500 AND CRYPTOGRAPHIC MODULE PHYSICAL CHARACTERISTICS	3
2.2	MODULE INTERFACES.....	3
2.3	ROLES AND SERVICES.....	10
	User Services	11
	Crypto Officer Services	12
2.4	UNAUTHENTICATED SERVICES	13
2.5	CRYPTOGRAPHIC KEY MANAGEMENT	13
2.6	CRYPTOGRAPHIC ALGORITHMS	16
	Approved Cryptographic Algorithms	16
	Non-FIPS Approved Algorithms Allowed in FIPS Mode	16
	Non-Approved Cryptographic Algorithms	17
2.7	SELF-TESTS	18
2.8	PHYSICAL SECURITY	19
	ASA 5580-20 and 5580-40 Opacity Shield	20
	ASA 5585-X Opacity Shield	21
	ASA 5512-X and 5515-X	23
	ASA 5580	24
	ASA 5585-X	25
	Applying Tamper Evidence Labels	27
3	SECURE OPERATION	27
3.1	CRYPTO OFFICER GUIDANCE - SYSTEM INITIALIZATION	27
3.2	CRYPTO OFFICER GUIDANCE - SYSTEM CONFIGURATION.....	28
3.3	IDENTIFYING ROUTER OPERATION IN AN APPROVED MODE.....	29

1 Introduction

1.1 Purpose

This is a non-proprietary Cryptographic Module Security Policy for the Cisco ASA 5512-X, ASA 5515-X, ASA 5525-X, ASA 5545-X, ASA 5555-X, ASA 5580-20, ASA 5580-40, ASA 5585-X SSP-10, 5585-X SSP-20, 5585-X SSP-40 and 5585-X SSP-60 Series Adaptive Security Appliances running Firmware 9.1.7.9; referred to in this document as appliances. This security policy describes how the modules meet the security requirements of FIPS 140-2 Level 2 and how to run the modules in a FIPS 140-2 mode of operation and may be freely distributed.

FIPS 140-2 (Federal Information Processing Standards Publication 140-2 — *Security Requirements for Cryptographic Modules*) details the U.S. Government requirements for cryptographic modules. More information about the FIPS 140-2 standard and validation program is available on the NIST website at <http://csrc.nist.gov/groups/STM/index.html>.

1.2 Module Validation Level

The following table lists the level of validation for each area in the FIPS PUB 140-2.

No.	Area Title	Level
1	Cryptographic Module Specification	2
2	Cryptographic Module Ports and Interfaces	2
3	Roles, Services, and Authentication	3
4	Finite State Model	2
5	Physical Security	2
6	Operational Environment	N/A
7	Cryptographic Key management	2
8	Electromagnetic Interface/Electromagnetic Compatibility	2
9	Self-Tests	2
10	Design Assurance	2
11	Mitigation of Other Attacks	N/A
	Overall module validation level	2

Table 1 Module Validation Level

1.3 References

This document deals only with operations and capabilities of those Cisco ASA 5512-X, ASA 5515-X, ASA 5525-X, ASA 5545-X, ASA 5555-X, ASA 5580-20, ASA 5580-40, ASA 5585-X SSP-10, 5585-X SSP-20, 5585-X SSP-40 and 5585-X SSP-60 models lists above in section 1.2 in the technical terms of a FIPS 140-2 cryptographic module security policy. More information is available on the routers from the following sources:

The Cisco Systems website contains information on the full line of Cisco Systems security. Please refer to the following website:

http://www.cisco.com/en/US/prod/collateral/vpndevc/ps6032/ps6094/ps6120/product_data_sheet_0900aecd802930c5.html

<http://www.cisco.com/en/US/products/ps6120/index.html>

For answers to technical or sales related questions please refer to the contacts listed on the Cisco Systems website at www.cisco.com.

The NIST Validated Modules website (<http://csrc.nist.gov/groups/STM/cmvp/validation.html>) contains contact information for answers to technical or sales-related questions for the module.

1.4 Terminology

In this document, those Cisco ASA 5500 models identified above are referred to as ASA 5500 Security Appliances, Appliances or the systems.

1.5 Document Organization

The Security Policy document is part of the FIPS 140-2 Submission Package. In addition to this document, the Submission Package contains:

- Vendor Evidence document
- Finite State Machine
- Other supporting documentation as additional references

This document provides an overview of the Cisco ASA 5500 Security Appliances models identified in section 1.2 above and explains the secure configuration and operation of the module. This introduction section is followed by Section 2, which details the general features and functionality of the appliances. Section 3 specifically addresses the required configuration for the FIPS-mode of operation.

With the exception of this Non-Proprietary Security Policy, the FIPS 140-2 Validation Submission Documentation is Cisco-proprietary and is releasable only under appropriate non-disclosure agreements. For access to these documents, please contact Cisco Systems.

2 Cisco ASA 5500 Security Appliances

The Cisco ASA 5500 Security Appliances leverage Cisco's expertise in security and VPN solutions, and integrates the latest technologies from Cisco PIX 500 series security appliances, Cisco IPS 4200 Series Intrusion Prevention Systems, and Cisco VPN 3000 series concentrators. The following subsections describe the physical characteristics of the ASA 5500 appliances. Cisco ASA 5500 Series Adaptive Security Appliances integrate world-class firewall, unified communications security, VPN, IPS, and content security services in a unified platform.

2.1 ASA 5500 and Cryptographic Module Physical Characteristics

The Cisco ASA 5500 Security Appliances delivers enterprise-class security for medium business-to-enterprise networks in a modular, purpose-built appliance. Its versatile one-rack unit (1RU, 5512, 5515, 5525, 5545 and 5555), two-rack unit (2RU, ASA 5585-10, 5585-20, 5585-40 and 5585-60) and four-rack unit (4RU, ASA 5580-20 and 5580-40) design supports 10/100/1000 Gigabit Ethernet ports interfaces (on the ASA 5512, 5515, 5525, 5545 and 5555), 1 10/100 Fast Ethernet ports Management interface, and 4 10/100/1000 Gigabit Ethernet ports RJ45 interfaces, 4 Port Gigabit Ethernet ports fiber, and 2 10/100/1000 Gigabit Ethernet ports Management interface (on the ASA 5580 and ASA 5585-X) making it an excellent choice for businesses requiring a cost-effective, resilient security solution with demilitarized zone (DMZ) support.

The following subsections describe the physical characteristics of the Cisco ASA 5512-X, ASA 5515-X, ASA 5525-X, ASA 5545-X, ASA 5555-X, ASA 5580-20, ASA 5580-40, ASA 5585-X SSP-10, 5585-X SSP-20, 5585-X SSP-40 and 5585-X SSP-60 which contains a multiple-chip standalone cryptographic module with the cryptographic boundary defined as the modules' chassis along with the opacity shields. This module is used to support Remote Access VPN With TLSv1/ DTLSv1 and IKEv2/ ESPv3, Secure Shell SSHv2, Secure Sockets Layer (TLS/TLSv1), SNMPv3 and IKE v2 Site-to-Site VPN (with IKEv1 / ESPv1, IKEv2 / ESPv3 & manual keying) with Suite B. These protocols are acceptable under FIPS 140-2 but are non-compliant for SP 800-135.

2.2 Module Interfaces

The module provides a number of physical and logical interfaces to the device, and the physical interfaces provided by the module are mapped to the following FIPS 140-2 defined logical interfaces: data input, data output, control input, status output, and power. The module provided no power to external devices and takes in its power through normal power input/cord. The logical interfaces and their mapping are described in the following tables:

FIPS 140-2 Logical Interface	ASA 5512, 5515, 5525, 5545, 5555 Physical Interface	ASA 55 Physical Interface	ASA 5585 Physical Interface
Data Input Interface	Ethernet ports MGMT Port Console Port	Ethernet ports MGMT Port Console Port	Ethernet ports MGMT Port Console Port
Data Output Interface	Ethernet ports MGMT Port Console Port	Ethernet ports MGMT Port Console Port	Ethernet ports MGMT Port Console Port
Control Input Interface	Ethernet ports MGMT Port Power Switch Console Port	Ethernet ports MGMT Port Console Port Reset Switch	Ethernet ports MGMT Port Console Port Reset Switch
Status Output Interface	Ethernet ports MGMT Port LEDs Console Port	Ethernet ports MGMT Port LEDs Console Port	Ethernet ports MGMT Port LEDs Console Port
Power Interface	Power Plug	Power Plug	Power Plug
Unused Interface	USB Port	USB Port	USB Port Aux Port

Table 2 Module Interfaces

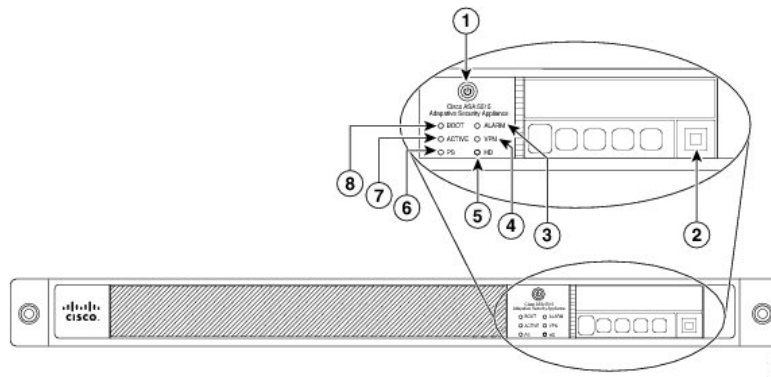

Figure 1 – Cisco ASA 5512, 5515 and 5525 Series Security Appliance Front Panel

LED	Description
1 Power button	A hard switch that turns the system on and off. Once depressed, the button stays in the "on" position: <ul style="list-style-type: none"> On—The power symbol on the button illuminates. Off—The power symbol on the button is dark. For information about the power state, see the "Power Supply Considerations" section .
2 Hard disk release button	Releases the hard disk from the device.
3 Alarm	Indicates system operating status: <ul style="list-style-type: none"> Off—Normal operating system function. Flashing amber—Critical Alarm indicating one or more of the following: <ul style="list-style-type: none"> a major failure of a hardware or software component. an over-temperature condition. power voltage is outside of the tolerance range.
4 VPN	Indicates VPN tunnel status: <ul style="list-style-type: none"> Solid green—VPN tunnel is established. Off—No VPN tunnel is established.
5 HD	Indicates Hard Disk Drive status: <ul style="list-style-type: none"> Flashing green—Proportioned to read/write activity. Solid amber—Hard disk drive failure. Off—No hard disk drive present.
6 PS	Indicates the power supply status
7 Active	Indicates the status of the failover pair: <ul style="list-style-type: none"> Solid green—Failover pair is operating normally. Off—Failover is not operational.
8 Boot	Indicates power-up diagnostics: <ul style="list-style-type: none"> Flashing green—Power-up diagnostics are running, or system is booting. Solid green—System has passed power-up diagnostics. Off—Power-up diagnostics are not operational.

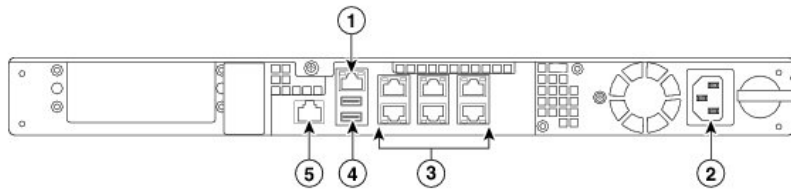

Figure 2 – Cisco ASA 5512, 5515 and 5525 Series Security Appliance Rear Panel

LED	Description
1 Management I/O interface	Indicates the Gigabit Ethernet interface that is restricted to management use only. Connect with an RJ-45 cable. (See the "Management I/O Interface on the ASA 5500-X Series" section .)
2 Power supply	Indicates the chassis power supply.
3 RJ-45 ports	Indicates the Gigabit Ethernet customer data interfaces. The top row port numbers are (from left to right) 5, 3, 1. The bottom row port numbers are (from left to right) 4, 2, 0.
4 USB Ports	Indicates the two USB standard ports. (See the "External USB Support" section .)
5 Console port	Indicates the console port that directly connects a computer to the ASA.

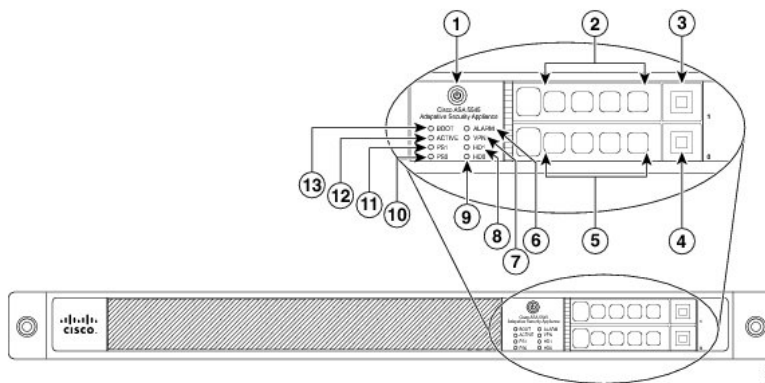

Figure 3 – Cisco ASA 5545 Series Security Appliance Front Panel

LED	Description
1 Power button	A hard switch that turns the system on and off. Once depressed, the button stays in the "on" position: <ul style="list-style-type: none"> On—The power symbol on the button illuminates. Off—The power symbol on the button is dark. For information about the power state, see the "Power Supply Considerations" section .
2 Hard disk slot	Indicates the slot for hard disk 1.
3 Hard disk release button	Releases hard disk 1 from the device.
4 Hard disk release button	Releases hard disk 0 from the device.
5 Hard disk slot	Indicates the slot for hard disk 0.
6 Alarm	Indicates system operating status: <ul style="list-style-type: none"> Off—Normal operating system function Flashing amber—Critical Alarm indicating one or more of the following: <ul style="list-style-type: none"> a major failure of a hardware or software component. an over-temperature condition. power voltage is outside of the tolerance range.
7 VPN	Indicates VPN tunnel status: <ul style="list-style-type: none"> Solid green—VPN tunnel is established. Off—No VPN tunnel is established.
8 HD1	Indicates Hard Disk Drive 1 status: <ul style="list-style-type: none"> Flashing green—Proportioned to read/write activity. Solid amber—Hard disk drive failure. Off—No hard disk drive present.
9 HD0	Indicates Hard Disk Drive 0 status: <ul style="list-style-type: none"> Flashing green—Proportioned to read/write activity. Solid amber—Hard disk drive failure. Off—No hard disk drive present.
10 PS1	Indicates the status of the optional redundant power supply.
11 PS0	Indicates the status of the primary power supply that ships with the product.
12 Active	Indicates the status of the failover pair: <ul style="list-style-type: none"> Solid green—Failover pair is operating normally. Off—Failover pair is not operational.
13 Boot	Indicates power-up diagnostics: <ul style="list-style-type: none"> Flashing green—Power-up diagnostics are running, or system is booting. Solid green—System has passed power-up diagnostics. Off—Power-up diagnostics are not operational.

LED	Description
1 Management 0/0 interface	Indicates the Gigabit Ethernet interface that is restricted to management use only. Connect with an RJ-45 cable. (See the "Management 0/0 Interface on the ASA 5500-X Series" section.)
2 Power supply	Indicates the chassis power supply.
3 RJ-45 ports	Indicates the Gigabit Ethernet customer data interfaces. The top row port numbers are (from left to right) 7, 5, 3, 1. The bottom row port numbers are (from left to right) 6, 4, 2, 0.
4 USB Ports	Indicates the two USB standard ports. (See the "External USB Support" section.)
5 Console port	Indicates the console port that directly connects a computer to the ASA.

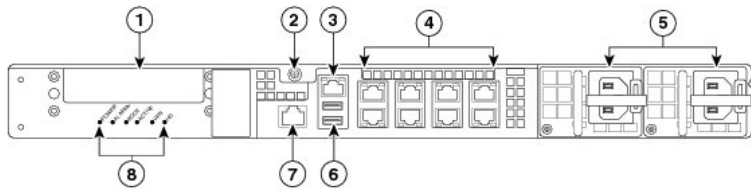

Figure 4 – Cisco ASA 5545 Series Security Appliance Rear Panel

LED	Description
1 I/O slot	Slot for the optional I/O Card. If you have a fiber I/O card, use SFP modules to connect (not included). (See the "Gigabit and Fibre Channel Ports" section.)
2 Thumbscrew	The screw that tightens and loosens the chassis cover.
3 Management 0/0 port	Indicates the Gigabit Ethernet interface that is restricted to management use only. Connect with an RJ-45 cable. (See the "Management 0/0 Interface on the ASA 5500-X Series" section.)
4 RJ-45 ports	Indicates the Gigabit Ethernet customer data interfaces. The top row port numbers are (from left to right) 7, 5, 3, 1. The bottom row port numbers are (from left to right) 6, 4, 2, 0.
5 Power supplies	Slots for the primary power supply that ships with the device and the optional redundant power supply.
6 USB ports	Indicates the two USB standard ports. (See the "External USB Support" section.)
7 Console port	Indicates the console port that directly connects a computer to the ASA.
8 Rear panel LEDs	Shows the rear panel LEDs. (See the "Rear Panel LEDs for ASA 5500-X Series Chassis" for more information.)

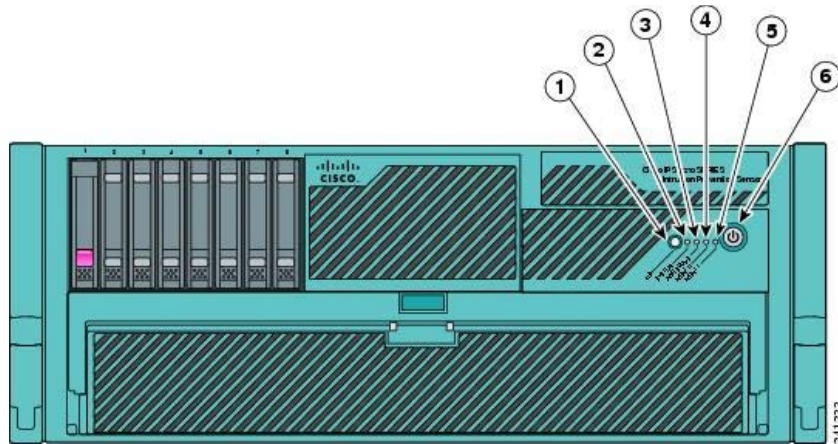

Figure 5 – Cisco ASA 5580 Series Security Appliance Front Panel

LED	Function
1	Active
2	System
3	Power Status
4	Management 0/0
5	Management 0/1
6	Power

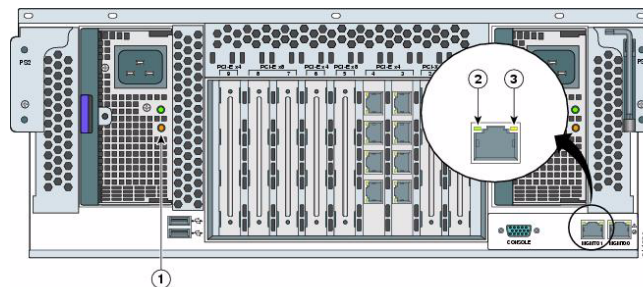

Figure 6 – Cisco ASA 5580 Series Security Appliance Rear Panel Indicators

1	Power Indicator
2	Link Indicator
3	Activity Indicator

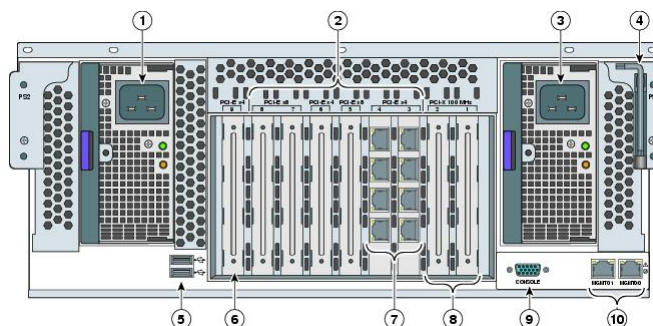

Figure 7 – Cisco ASA 5580 Series Security Appliance Rear Panel

1	Power Supply	6	Reserved Slot
2	Interface Expansion Slots	7	Example of Populated Slot
3	Power Supply	8	Reserved Slot
4	T-15 Torx Screwdriver	9	Console port
5	USB Ports	10	Management ports

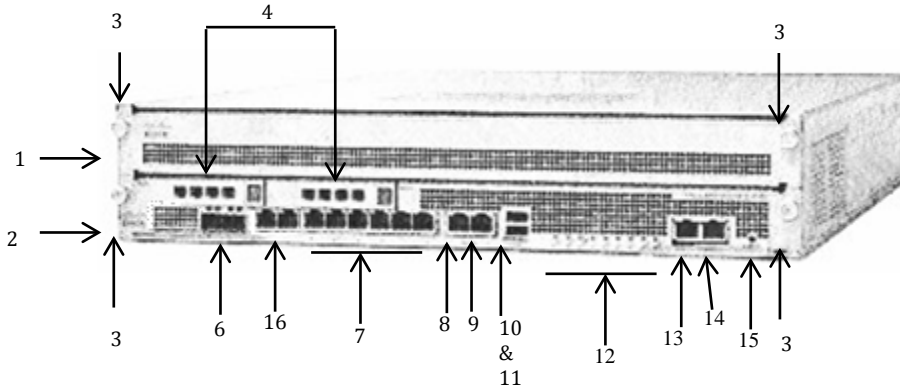

Figure 8 – Cisco ASA 5585-X SSP-10 and SSP-20 Series Security Appliance Front Panel

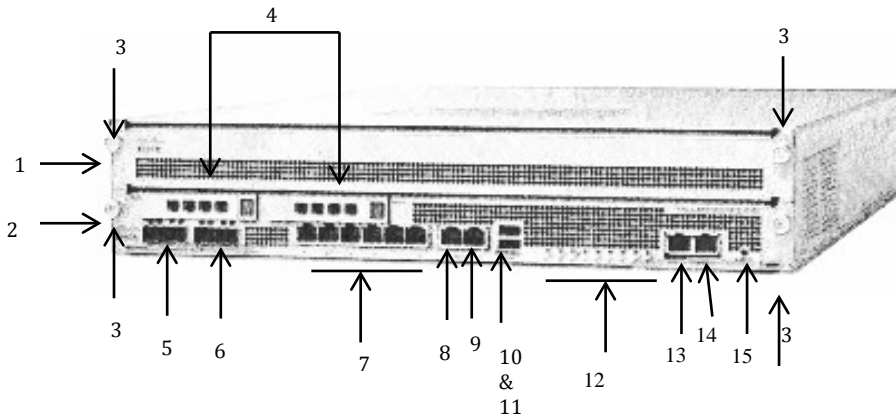

Figure 9 – Cisco ASA 5585-X SSP-40 and SSP-60 Series Security Appliance Front Panel

1	IPS SSP	9	Management
2	SSP	10	USB port
3	SSP/IPS SSP removal screws	11	USB port
4	Reserved bays for hard-disk drives	12	Front panel indicators
5	Ethernet ports (not present on SSP 10 or SSP 20) Vent (on SSP 10 and SSP 20)	13	Auxiliary port (RJ45)
6	Ethernet ports	14	Console port (RJ45)
7	Ethernet ports	15	Eject
8	Management	16	Vent (on SSP 40 and SSP 60) and Ethernet ports (on SSP 10 or SSP 20)

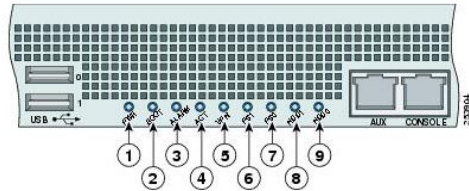

Figure 10 – Cisco ASA 5585-X Series Security Appliance Rear Panel Indicators

1	PWR	6	PS1
2	BOOT	7	PS0
3	ALARM	8	HDD1
4	ACT	9	HDD2
5	VPN		

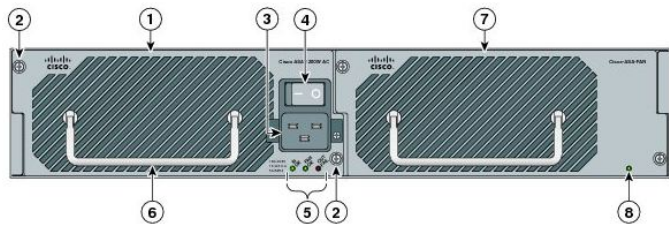

Figure 11 – Cisco ASA 5585-X Series Security Appliance Rear Panel

1	Power supply module	5	Power supply module indicators
2	Power supply module/fan module removal screws	6	Power supply module or fan module handle
3	Power supply module plug	7	Fan module
4	Toggle On/Off switch for power	8	Fan module indicator

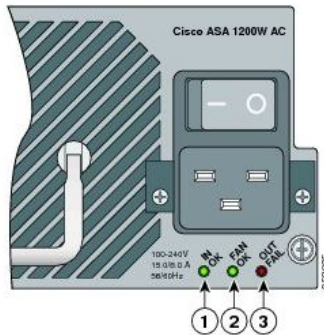

Figure 12 – Cisco ASA 5585-X Series Security Appliance Rear Panel Indicators

1	AC ON	2	FAN OK	3	OUT FAIL
---	-------	---	--------	---	----------

2.3 Roles and Services

The security appliances can be accessed in one of the following ways:

- Console Port
- Telnet over IPSec

- SSH v2
- ASDM via HTTPS/TLS

Authentication is identity-based. Each user is authenticated by the module upon initial access to the module. As required by FIPS 140-2, there are two roles in the security appliances that operators may assume: a Crypto Officer role and User role. The administrator of the security appliances assumes the Crypto Officer role in order to configure and maintain the router using Crypto Officer services, while the Users exercise only the basic User services. The module also supports RADIUS and TACACS+ as another means of authentication, allowing the storage of usernames and passwords on an external server as opposed to using the module's internal database for storage.

The User and Crypto Officer passwords and all shared secrets must each be at least eight (8) characters long, including at least one letter and at least one number character, in length (enforced procedurally). See the Secure Operation section for more information. If six (6) integers, one (1) special character and one (1) alphabet are used without repetition for an eight (8) digit PIN, the probability of randomly guessing the correct sequence is one (1) in 251,596,800. This is calculated by performing $10 \times 9 \times 8 \times 7 \times 6 \times 5 \times 32 \times 52$. In order to successfully guess the sequence in one minute would require the ability to make over 4,193,280 guesses per second, which far exceeds the operational capabilities of the module. Including the rest of the alphanumeric characters drastically decreases the odds of guessing the correct sequence.”

Additionally, when using RSA based authentication, RSA key pair has modulus size of 2048 bits to 4096 bits, thus providing between 112 bits and 224 bits of strength. Assuming the low end of that range, an attacker would have a 1 in 2^{112} chance of randomly obtaining the key, which is much stronger than the one in a million chance required by FIPS 140-2. To exceed a one in 100,000 probability of a successful random key guess in one minute, an attacker would have to be capable of approximately 1.8×10^{21} attempts per minute, which far exceeds the operational capabilities of the modules to support

The User and Crypto Officer passwords and all shared secrets must each be at least eight (8) characters long, including at least one letter and at least one number character, in length (enforced procedurally).

User Services

Users can access the system in two ways:

1. By accessing the console port with a terminal program or via IPSec protected telnet or SSH session to an Ethernet ports port. The IOS prompts the User for username and password. If the password is correct, the User is allowed entry to the IOS executive program.
2. Via an IPSec session. This session is authenticated either using a shared secret or RSA digital signature authentication mechanism.

The services available to the User role consist of the following (r=read, w= write, x=execute, z=zeroize):

Services & Access	Description	Keys & CSPs
Status Functions (r)	Image version currently running, installed hardware components, and version of hardware installed.	User password
Network Functions (r, w, x)	Initiate diagnostic network services, such as ping.	User password
VPN functions (r, x)	Negotiation and encrypted data transport via VPN	ISAKMP pre-shared keys, IKE Authentication key, IKE Encryption Key, IPSec authentication keys, IPSec traffic keys, User passwords
Directory Services (r, x)	Display directory of files kept in flash memory.	User password
Perform Self-Tests (r, x)	Execute Known Answer Test on Algorithms within the cryptographic module.	N/A

Table 3 - User Services

Crypto Officer Services

The Crypto Officer role is responsible for the configuration and maintenance of the security appliances and authenticates from the **enable** command (for local authentication) or the **login** command (for AAA authentication) from the user services. The Crypto Officer services consist of the following:

The Crypto Officer services consist of the following:

Services & Access	Description	Keys & CSPs
Configure the Security Appliance (r, w, z)	Define network interfaces and settings; provide for the entry and output of CSPs; set the protocols the security appliances will support; enable interfaces and network services; set system date and time; load authentication information; and configure authentication servers, filters and access lists for interfaces and users, and privileges.	ISAKMP pre-shared keys, IKE Authentication key, IKE Encryption Key, IPSec authentication keys, IPSec traffic keys, User passwords, Enable password, Enable secret,
Define Rules and Filters (r, w, z)	Create packet Filters that are applied to User data streams on each interface. Each Filter consists of a set of Rules, which define a set of packets to permit or deny based on characteristics such as protocol ID, addresses, ports, TCP connection establishment, or packet direction.	password
View Status Functions (r, x)	View the configuration, routing tables, active sessions, use SNMP queries to view SNMP MIB statistics, health, temperature, memory status, packet statistics, review accounting logs, and view physical interface status.	password
Manage the Security Appliance (r, w, z)	Log off users, provide for the entry and output of CSPs, shutdown or reload the security appliances, view complete configurations, view full status, manage user rights, and restore configurations.	password
Set Encryption/Bypass (r, w, x, z)	Set up the configuration tables for IP tunneling. Set keys and algorithms to be used for each IP range or allow plain text packets to be sent from specified IP address. Set up site to site VPN for IPv6.	ISAKMP pre-shared keys, IKE Authentication key, IKE Encryption Key, IPSec authentication keys, IPSec traffic keys, Enable secret,
Perform Self-Tests (r, x)	Execute Known Answer Test on Algorithms within the cryptographic module.	N/A
SSL VPN (using TLSv1.0) (r, w, x, z)	Configure SSL VPN parameters, provide entry and output of CSPs.	TLS pre-master secret, TLS Traffic Keys
Local Certificate Authority (r, w, z)	Allows the ASA to be configured as a Root Certificate Authority and issue user certificates for SSL VPN use (AnyConnect and Clientless). The ASA can then be configured to require client certificates for authentication.	N/A

Table 4 - Crypto Officer Services

2.4 Unauthenticated Services

The services available to unauthenticated users are:

- Viewing the status output from the module's LEDs
- Powering the module on and off using the power switch on the third-party chassis
- Performing bypass service

2.5 Cryptographic Key Management

The ASA 5500 administers both cryptographic keys and other critical security parameters such as passwords. All keys and CSPs are protected by the password-protection on the Crypto Officer role login, and can be zeroized by the Crypto Officer. Zeroization consists of overwriting the memory that stored the key or refreshing the volatile memory. Keys are both manually and electronically distributed but entered electronically. Persistent keys with manual distribution are used for pre-shared keys whereas protocols such as IKE, TLS and SSH are used for electronic distribution.

The ASA 5500 module securely administers both cryptographic keys and other critical security parameters such as passwords. The tamper evidence seals provide physical protection for all keys. All pre-shared keys are associated with the CO role that created the keys, and the CO role is protected by a password. Therefore, the CO password is associated with all the pre-shared keys. The Crypto Officer needs to be authenticated to store keys. Only an authenticated Crypto Officer can view the keys. All Diffie-Hellman (DH) keys agreed upon for individual tunnels are directly associated with that specific tunnel only via the IKE protocol. RSA Public keys are entered into the modules using digital certificates which contain relevant data such as the name of the public key's owner, which associates the key with the correct entity. All other keys are associated with the user/role that entered them.

The module pulls in 32 bytes of entropy from a high-jitter free-running oscillators for use with the DRBG. This equates to greater than 112 bits of entropy.

Key/CSP	Generation	Description	Storage	Zeroization
Diffie-Hellman private exponent	Diffie-Hellman	Key agreement for IKE, TLS, and SSH sessions. Diffie-Hellman groups 1 (768 bits of keying strength), 2 (1024 bits), 5 (1536 bits) and 7 (2048 bits) are supported. Please note that groups 1, 2 and 5 are not to be used in FIPS mode. This key was generated by calling FIPS approved SP800-90a DRBG	DRAM (plain text)	Automatically when session expires
Diffie-Hellman shared secret	Diffie-Hellman	This is the shared secret agreed upon as part of DH exchange. This key was generated by the module.	DRAM (plain text)	Automatically when session expires
Diffie-Hellman public exponent	Diffie-Hellman	Key agreement for IKE, TLS, and SSH sessions. Diffie-Hellman groups 1 (768 bits of keying strength), 2 (1024 bits), 5 (1536 bits) and 7	DRAM (plain text)	Automatically when session expires

		(2048 bits) are supported. Please note that groups 1, 2 and 5 are not to be used in FIPS mode. This key was generated by calling FIPS approved SP800-90a DRBG		
RSA private keys	RSA 2048	Identity certificates for the security appliance itself and also used in IPSec, TLS, and SSH negotiations. The security appliances support 512, 768, 1024 and 2048 bit key sizes (512, 768 and 1024-bit key lengths are not to be used in FIPS mode). This key was generated by calling FIPS approved SP800-90a DRBG	Private Key - NVRAM (plain text)	Zeroized by “#crypto key zeroize rsa”, write to startup config, followed by a module reboot
RSA public keys	RSA 2048	Identity certificates for the security appliance itself and also used in IPSec, TLS, and SSH negotiations. The security appliances support 512, 768, 1024 and 2048 bit key sizes (512, 768 and 1024-bit key lengths are not to be used in FIPS mode). This key is generated by calling FIPS approved SP800-90a DRBG	Public Key - NVRAM (plain text)	Zeroized by “#crypto key zeroize rsa”, write to startup config, followed by a module reboot
skeyid	HMAC-SHA1/256/384/512	Value derived from the shared secret within IKE exchange.	DRAM (plain text)	Automatically after IKE session is terminated
skeyid_d	HMAC-SHA1/256/384/512	Value derived from the shared secret within IKE exchange.	DRAM (plain text)	Automatically after IKE session is terminated
ISAKMP pre-shared secret	Shared Secret	Used for authentication during IKE. This key was configured by Crypto Officer.	NVRAM (plain text)	Zeroized by “#erase flash:” command (or replacing), write to startup config, followed by a module reboot
IKE authentication key	HMAC-SHA1/256/384/512	This key is used to authenticate IKE sessions. This key was derived in the module.	DRAM (plain text)	Automatically after IKE session is terminated or by resetting the appliances
IKE encryption key	Triple-Des/AES 128/192/256	Used to encrypt IKE negotiations. This key was derived in the module.	DRAM (plain text)	Automatically after IKE session is terminated or by resetting the appliances
AES-GCM Encryption/decryption	AES-GCM 128/192/256	Symmetric Cipher Encrypts data blocks while performing decrypt-on-the-fly verification Decrypts data block	DRAM (plain text)	AES keys are dynamically generated IAW the RFCs and are not persistent, the new keys are regenerated for any AES-GCM connection after power is removed and restored.
IPSec authentication key	HMAC-SHA1/256/384/512	Exchanged using the IKE protocol and the public/private key pairs. These are Triple-DES or AES keys. This key was derived in	DRAM (plain text)	Automatically after IPSec session is terminated or by resetting the appliances

		the module.		
IPSec traffic keys	Triple-Des/AES 128/192/256 HMAC- SHA1/256/384/512	Exchanged using the IKE protocol and the public/private key pairs. These are Triple-DES or AES keys. This key was derived in the module.	DRAM (plain text)	Automatically after IPSec session is terminated or by resetting the appliances
RADIUS shared secret	Shared Secret	Used for authenticating the RADIUS server to the security appliances and vice versa. This key was configured by Crypto Officer.	NVRAM (plain text)	Zeroized by “#erase flash:” command (or replacing), write to startup config, followed by a module reboot
TACACS+ shared secret	Shared Secret	Used for authenticating the TACACS+ server to the security appliances and vice versa. This key was configured by Crypto Officer.	NVRAM (plain text)	Zeroized by “#erase flash:” command (or replacing), write to startup config, followed by a module reboot”
User password	Shared Secret	Critical security parameters used to authenticate the User/Crypto-Officer login. This key was configured by Crypto Officer.	NVRAM (plaintext)	Overwrite with new password
Enable password	Shared Secret	Configured by Crypto Officer. It is used to authenticate Crypto officer.	NVRAM (plaintext)	Overwrite with new password
Enable secret	Shared Secret	Configured by Crypto Officer. It is used to authenticate Crypto officer role.	NVRAM (plaintext)	Overwrite with new password
TLS pre-master secret	Shared Secret	Shared secret created/derived using asymmetric cryptography from which new HTTPS session keys can be created. This key entered into the module in cipher text form, encrypted by RSA public key.	DRAM (plaintext)	Automatically when TLS session is terminated.
TLS traffic keys	Triple-DES/AES 128/192/256 HMAC- SHA1/256/384/512	Used in HTTPS connections. Generated using TLS protocol. This key was derived in the module.	DRAM (plain text)	Automatically when TLS session is terminated
SSH v2 authentication keys	HMAC- SHA1/256/384/512	This key is used to perform the authentication between the SSH client and SSH server. This key was derived in the module.	DRAM (plain text)	Zeroized automatically when SSH session is closed
SSH v2 session encryption keys	Triple-Des/AES 128/192/256	This is the symmetric SSH key used to protect SSH session. This key was derived in the module.	DRAM (plain text)	Zeroized automatically when SSH session is closed
ECDSA private key	ECDSA P-256,384,521	Key pair generation, signature generation/ verification	DRAM	Zeroized upon API call “#crypto key zeroize ecdsa”
ECDSA public key	ECDSA P-256,384,521	Key pair generation, signature generation/ verification	DRAM	Zeroized upon API call “#crypto key zeroize ecdsa”

DRBG Seed	SHA-512 Hash DRBG	This is the internal value generated by the module and used in the DRBG	DRAM	Power cycle the module
DRBG V value	SHA-512 Hash DRBG	This is the internal value generated by the module and used in the DRBG	DRAM	Power cycle the module
DRBG C value	SHA-512 Hash DRBG	This is the internal value generated by the module and used in the DRBG	DRAM	Power cycle the module

Table 5 Cryptographic Keys and CSPs

2.6 Cryptographic Algorithms

The module implements a variety of approved and non-approved algorithms.

Approved Cryptographic Algorithms

The routers support the following FIPS-2 approved algorithm implementations:

Algorithms	Algorithm Certificate Numbers				
	Adaptive Security Appliance OS(Firmware Algorithm Implementation)		ASA On-board (Cavium Nitrox PX) (ASA 5512-X, 5515-X, 5525-X, 5545-X)	ASA On-board (Cavium Nitrox PX) (ASA 5580-20, 5580-40)	ASA On-board (Cavium Nitrox PX) (ASA 5585-X SSP10, 5585-X SSP20, 5585-X SSP40, 5585-X SSP60, 5545-X, 5555-X)
			ASA CN1610	ASA CN1520	ASA CN1620
AES	2483	2482	2472	1407 & 2480	2050 & 2444
Triple-DES	1521	1520	1513	960	1321
SHS	2101	2100	2091	1793	1794
HMAC	1525	1524	1514	1246	1247
RSA	1272	1271	1260	1269	1066
ECDSA	412	411			
DRBG		341	336	339	332

Table 6 Approved Cryptographic Algorithms

Non-FIPS Approved Algorithms Allowed in FIPS Mode

The module supports the following non-FIPS approved algorithms which are permitted for use in the FIPS approved mode:

- Diffie-Hellman (key agreement; key establishment methodology provides 112 bits of encryption strength; non-compliant less than 112 bits of encryption strength)

- RSA (key wrapping; key establishment methodology provides 112 bits of encryption strength; non-compliant less than 112 bits of encryption strength)

Non-Approved Cryptographic Algorithms

The module supports the following non-approved cryptographic algorithms that shall not be used in FIPS mode of operation:

- DES
- HMAC MD5
- MD5¹
- NDRNG
- RC4
- RNG
- HMAC-SHA1 is not allowed with key size under 112-bits
- RSA (Cert. #106; non-compliant with the functions from the CAVP Historical RSA list)
 - FIPS186-2:
ALG[RSASSA-PKCS1_V1_5]: SIG(gen): 1024 , 2048 , SHS: SHA-1
- RSA (Cert. #261; non-compliant with the functions from the CAVP Historical RSA list)
 - FIPS186-2:
ALG[RSASSA-PKCS1_V1_5]: SIG(gen): 1024 , 2048 , SHS: SHA-1
- RSA (Cert. #1066; non-compliant with the functions from the CAVP Historical RSA list)
 - FIPS186-2:
ALG[RSASSA-PKCS1_V1_5]: SIG(gen): 1024 , SHS: SHA-1, SHA-256, SHA-384, SHA-512, 2048 , SHS: SHA-1
- RSA (Cert. #1260; non-compliant with the functions from the CAVP Historical RSA list)
 - FIPS186-2:
ALG[RSASSA-PKCS1_V1_5]: SIG(gen): 1024 , SHS: SHA-1, SHA-256, SHA-384, SHA-512, 2048 , 4096 , SHS: SHA-1
- RSA (Cert. #1269; non-compliant with the functions from the CAVP Historical RSA list)
 - FIPS186-2:
ALG[RSASSA-PKCS1_V1_5]: SIG(gen): 1024 , SHS: SHA-1, SHA-256, SHA-384, SHA-512, 2048 , SHS: SHA-1
- RSA (Cert. #1271; non-compliant with the functions from the CAVP Historical RSA list)
 - FIPS186-2:
ALG[ANSIX9.31]: Key(gen)(MOD: 1024 PubKey Values: 65537
ALG[RSASSA-PKCS1_V1_5]: SIG(gen): 1024 , SHS: SHA-1, SHA-256, SHA-384, SHA-512, 2048 , 4096 , SHS: SHA-1

¹ Allowed in FIPS mode

- RSA (Cert. #1272; non-compliant with the functions from the CAVP Historical RSA list)
 - FIPS186-2:
 - ALG[ANSIX9.31]: Key(gen)(MOD: 1024 PubKey Values: 65537
 - ALG[RSASSA-PKCS1_V1_5]: SIG(gen): 1024 , SHS: SHA-1, SHA-256, SHA-384, SHA-512, 2048 , SHS: SHA-1

2.7 Self-Tests

The modules include an array of self-tests that are run during startup and periodically during operations to prevent any secure data from being released and to insure all components are functioning correctly.

Self-tests performed

- ASA Self Tests
 - POSTs – Adaptive Security Appliance OS (Firmware)
 - AES GCM KAT
 - AES Encrypt/Decrypt KATs
 - DRBG KAT
 - ECDSA
 - Firmware Integrity Test (using SHA-512)
 - HMAC-SHA-1 KAT
 - HMAC-SHA-256 KAT
 - HMAC-SHA-384 KAT
 - HMAC-SHA-512 KAT
 - RSA KAT
 - SHA-1 KAT
 - SHA-256 KAT
 - SHA-384 KAT
 - SHA-512 KAT
 - Triple-DES Encrypt/Decrypt KATs
 - POSTs – ASA On-board (Hardware)
 - AES Encrypt/Decrypt KATs
 - DRBG KAT
 - HMAC-SHA-1 KAT
 - HMAC-SHA-256 KAT (5580 and 5585 models only)
 - HMAC-SHA-384 KAT (5580 and 5585 models only)
 - HMAC-SHA-512 KAT (5580 and 5585 models only)
 - RSA KAT
 - SHA-1 KAT
 - SHA-256 KAT (5580 and 5585 models only)
 - SHA-384 KAT (5580 and 5585 models only)
 - SHA-512 KAT (5580 and 5585 models only)

- Triple-DES Encrypt/Decrypt KATs
- Conditional tests - Adaptive Security Appliance OS (Firmware)
 - RSA pairwise consistency test (encrypt/decrypt and sign/verify)
 - ECDSA pairwise consistency test
 - Conditional Bypass test
 - Continuous random number generation test for FIPS approved and non-approved RNG
- Conditional tests - ASA On-board (Hardware)
 - RSA pairwise consistency test (encrypt/decrypt and sign/verify)
 - Continuous random number generation test for FIPS approved SP 800-90a DRBG

The security appliances perform all power-on self-tests automatically at boot when FIPS mode is enabled. All power-on self-tests must be passed before a User/Crypto Officer can perform services. The power-on self-tests are performed after the cryptographic systems are initialized but prior to the initialization of the LAN's interfaces; this prevents the security appliances from passing any data during a power-on self-test failure. In the unlikely event that a power-on self-test fails, an error message is displayed on the console followed by a security appliance reboot.

2.8 Physical Security

The FIPS 140-2 level 2 physical security requirements for the modules are met by the use of opacity shields covering the front panels of modules to provide the required opacity and tamper evident seals to provide the required tamper evidence. The following sections illustrate the physical security provided by the module.

The following table shows the tamper labels and opacity shields that shall be installed on the modules to operate in a FIPS approved mode of operation. The CO is responsible for using, securing and having control at all times of any unused tamper evident labels. Actions to be taken when any evidence of tampering should be addressed within site security program.

Model	Number Tamper labels	Tamper Evident Labels	Number Opacity Shields	Opacity Shields
5512-X,5515-X,5525-X,5545-X,5555-X	3	DS-FIPS-KIT= Rev –BO	0	None
5580	17	ASA5580-FIPS-KIT	2	ASA5580-FIPS-KIT
5585-X	8	ASA5585-X-FIPS-KIT	1	ASA5585-X-FIPS-KIT

Table 7 – Tamper/Opacity

ASA 5580-20 and 5580-40 Opacity Shield

To install an opacity shield on the ASA 5580 front and rear, follow these steps:

Step 1: Power off the ASA.

Step 2: Copy the ASA 5580 serial number on a label and stick it on the chassis where it can be retrieved easily for future use,

Step 3: Release the latches on the lever

Step 4: Lower the handle, and pull the module out of the ASA until the release latches catch.

Step 5: Remove the five screws from the top and four screws on the sides of the front shield assembly. Keep the screws in a secure place for later use.

Step 6: Clean the chassis of any grease, dirt or oil with alcohol where the self-adhesive tape will stick on the chassis.

Step 7: Place the front surround panel over the front of the module so that the roller balls on the top of the module are visible through the matching openings on the surround panel

Step 8: Remove the tape backing from the self-adhesive tape.

Step 9: Press down the self-adhesive tape to make sure the front surround panel is firmly stuck to the chassis.

Step 10: Push the module back into the chassis and use the handle to lock the module into place

Step 11: Install the front panel inside the front surround panel and secure it with the nine screws you removed in Step 5.

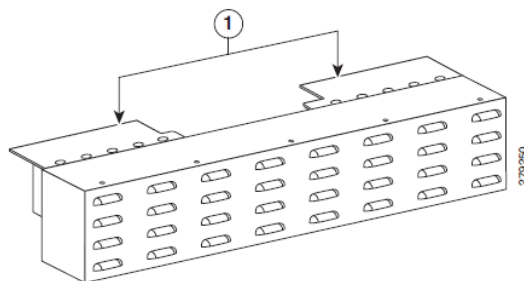

Figure 13 – ASA 5580 Front Opacity Shield Placement

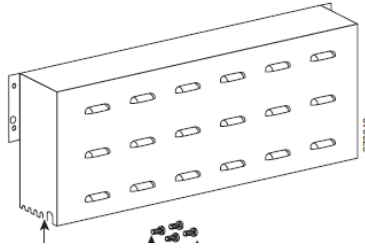

Figure 14 – ASA 5580 Rear Opacity Shield Placement

ASA 5585-X Opacity Shield

Step 1: Position the rear shield assembly on the rear of the chassis and align the rear shield panel holes with the holes on the rear of the chassis.

Step 2: Secure the shield into place using the screws provided in the kit

Step 3: Connect the power source and power on the chassis.

To install an opacity shield on the ASA 5585-X, follow these steps:

Step 1: Power off the ASA.

If you have not installed the cable management brackets, you can do it now. The cable management brackets will make it easier to manage all your cables.

Step 2: Position the cable management brackets on the front side of the ASA, and line up the bracket screws with the screw holes on the ASA.

Step 3: Tighten the screws in to the rack.

Step 4: Screw the rods to the holes above the cable management brackets.

Step 5: Place the FIPS opacity shield over the rods, align the holes on the FIPS opacity shield with the holes on the rods.

Step 6: Tighten the screws.

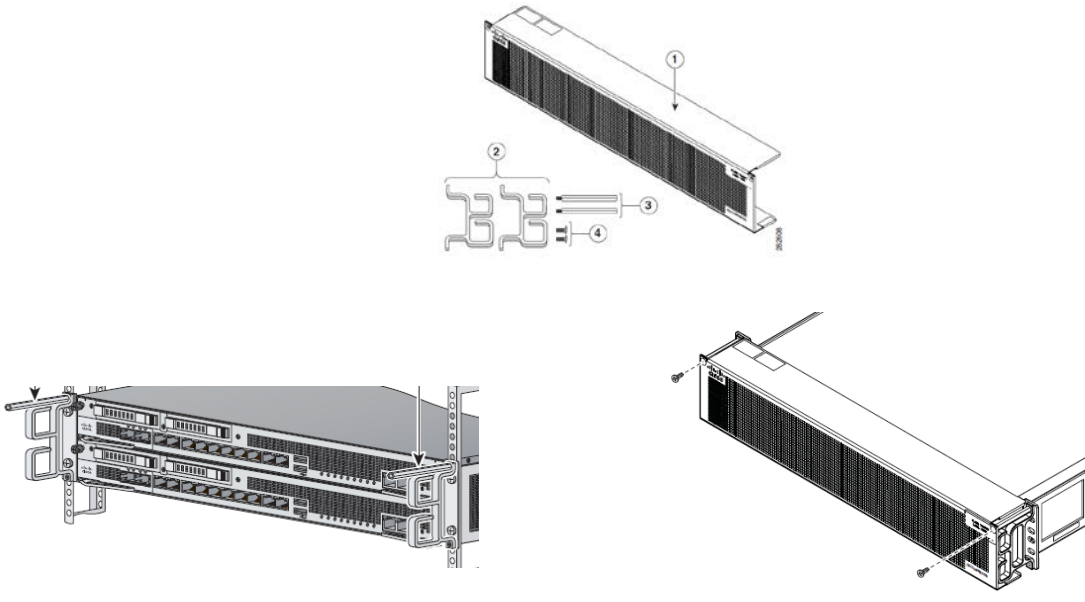

Figure 15 – ASA 5585-X Front Opacity Shield Placement

Tamper Evidence Labels (TELs)

Once the module has been configured to meet overall FIPS 140-2 Level 2 requirements, the module cannot be accessed without signs of tampering. The CO shall inspect for signs of tampering periodically.

To seal the system, apply tamper-evidence labels as depicted in the figures below.

ASA 5512-X and 5515-X



Figure 16 Cisco ASA5512-X and ASA5515-X Front

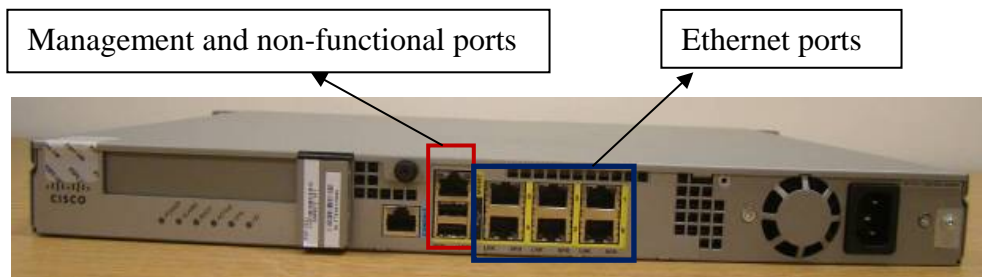
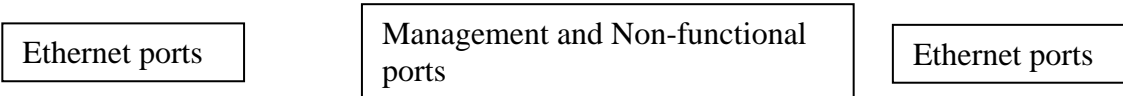

Figure 17 Cisco ASA5512-X and ASA5515-X Rear

ASA 5525-X and 5545-X



Figure 18 Cisco ASA5525 Front



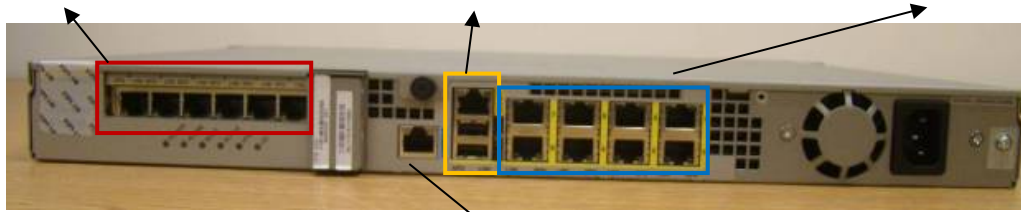

Figure 19 Cisco ASA5525 Back

Console Port

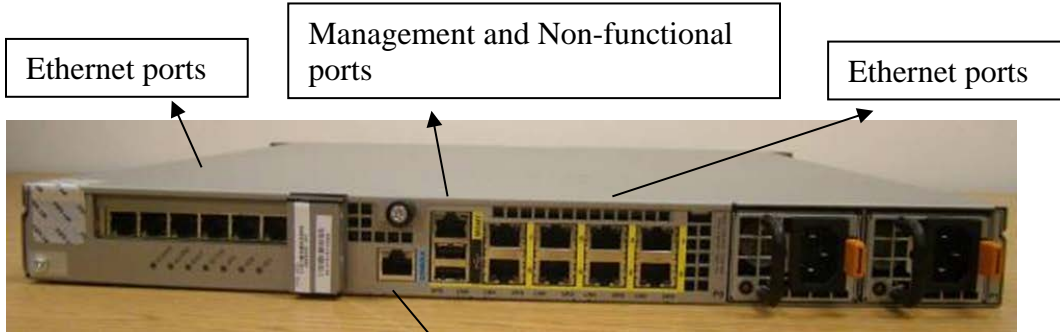

Figure 20 Cisco ASA5545 Back

Console Port

ASA 5580

Apply the 17 tamper evident labels as follows:

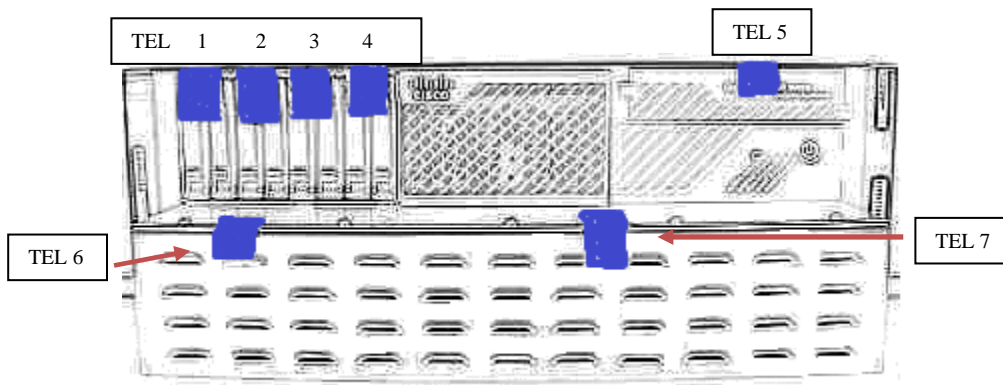

Figure 21 Cisco ASA 5580 Security Appliance Tamper Evident Label Placement (Front Face)

TEL 8

TEL 9

TEL 10

TEL 11

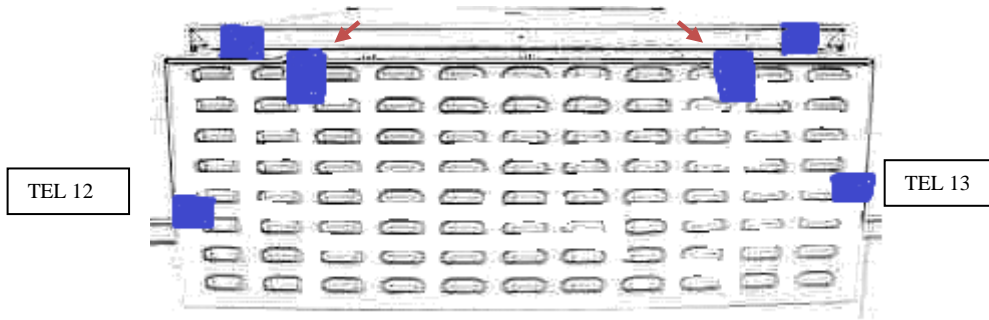

Figure 22 Cisco ASA 5580 Security Appliance Tamper Evident Label Placement (Back Face)

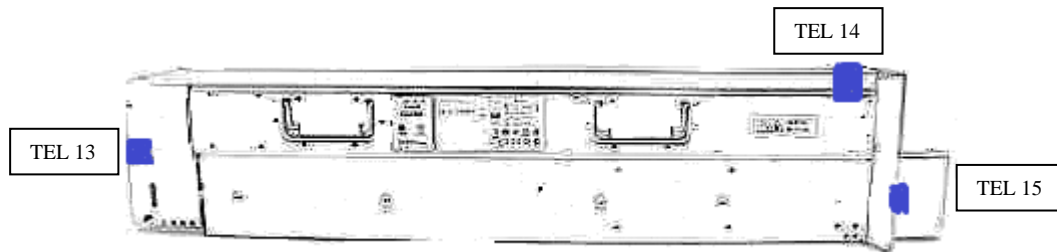

Figure 23 Cisco ASA 5580 Security Appliance Tamper Evident Label Placement (Side Face)

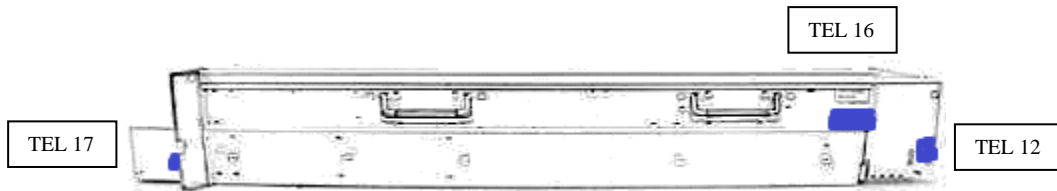

Figure 24 Cisco ASA 5580 Security Appliance Tamper Evident Label Placement (Side Face)

ASA 5585-X

Apply the 8 tamper evident labels as follows:

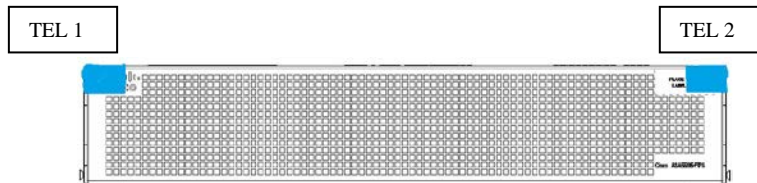

Figure 25 Cisco ASA 5585 Security Appliance with opacity shield and Tamper Evident Label Placement (Front Face)

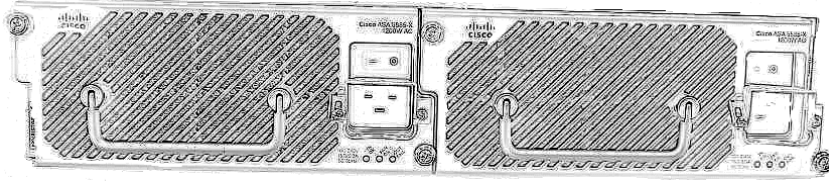

Figure 26 Cisco ASA 5585 Security Appliance (Rear Face)

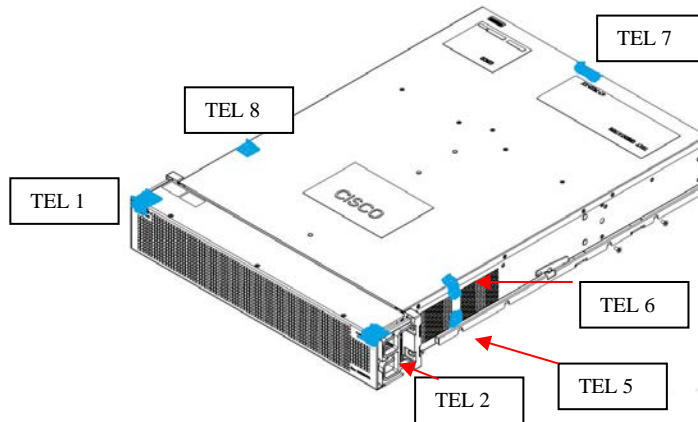

Figure 27 Cisco ASA 5585 Security Appliance (Front, top and right side)

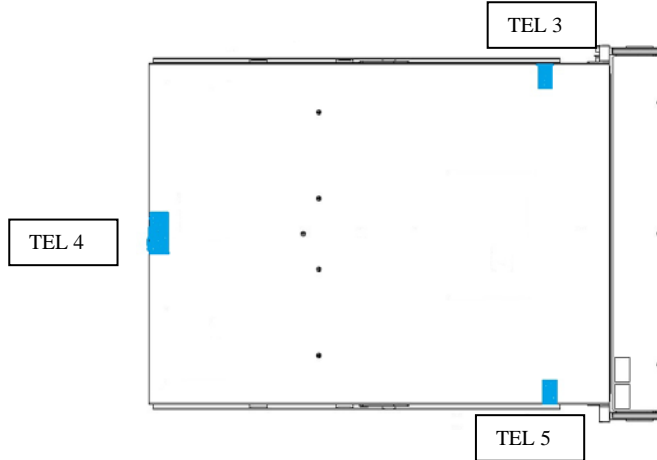

Figure 28 Cisco ASA 5585 Security Appliance with Tamper Evident Label Placement (Bottom Face)

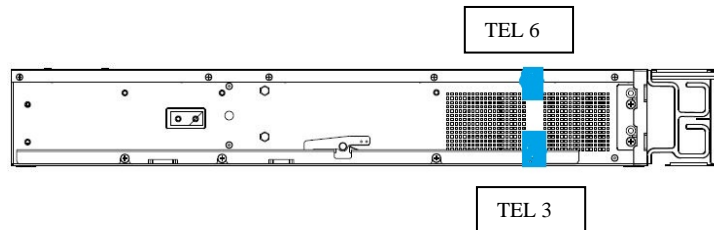

Figure 29 Cisco ASA 5585 Security Appliance with Tamper Evident Label Placement (Left Face)

Applying Tamper Evidence Labels

Step 1: Turn off and unplug the system before cleaning the chassis and applying labels.

Step 2: Clean the chassis of any grease, dirt, or oil before applying the tamper evident labels. Alcohol-based cleaning pads are recommended for this purpose.

Step 3: Apply a label to cover the security appliance as shown in figures above.

The tamper evident seals are produced from a special thin gauge vinyl with self-adhesive backing. Any attempt to open the device will damage the tamper evident seals or the material of the security appliance cover. Because the tamper evident seals have non-repeated serial numbers, they may be inspected for damage and compared against the applied serial numbers to verify that the security appliance has not been tampered with. Tamper evident seals can also be inspected for signs of tampering, which include the following: curled corners, rips, and slices. The word “OPEN” may appear if the label was peeled back.

3 Secure Operation

The module meets all the Level 2 requirements for FIPS 140-2. The module is shipped only to authorized operators by the vendor, and the modules are shipped in Cisco boxes with Cisco adhesive. Follow the setting instructions provided below to place the module in FIPS-approved mode. Operating this router without maintaining the following settings will remove the module from the FIPS approved mode of operation.

3.1 Crypto Officer Guidance - System Initialization

The Cisco ASA 5500 series security appliances were validated with adaptive security appliance firmware version 9.1.7.9 (file name: asa917-9-smp-k8.bin) for 5512-X, 5515-X, 5525-X, 5545-X, 5555-X, 5580-20, 5580-40, 5585-X SSP-10, 5585-X SSP-20, 5585-X SSP-40 and 5585-X SSP-60. These are the only allowable images for FIPS-approved mode of operation.

The Crypto Officer must configure and enforce the following initialization steps:

Step 1: Disable the console output of system crash information, using the following command:
(config)#**crashinfo console disable**

Step 2: Install Triple-DES/AES licenses to require the security appliances to use Triple-DES and AES (for data traffic and SSH).

Step 3: Enable “FIPS Mode” to allow the security appliances to internally enforce FIPS-compliant behavior, such as run power-on self-tests and bypass test, using the following command:

(config)# **fips enable**

Step 4: Disable password recovery.

```
(config)#no service password-recovery
```

Step 5: Set the configuration register to bypass ROMMON prompt at boot.

```
(config)# config-register 0x10011
```

Step 6: If using a Radius/TACACS+ server for authentication, perform the following steps.(see Operator manual for specific TACACS+ commands) Otherwise, skip to step 7

```
(config)# aaa-server radius-server protocol radius  
(config)# aaa-server radius-server host <IP-address>
```

Configure an IPsec tunnel to secure traffic between the ASA and the Radius server.
The pre-shared key must be at least 8 characters long.

Step 7: Enable AAA **authentication** for the console.

```
(config)#aaa authentication serial console LOCAL  
(config)#username <name> password <password>
```

Step 8: Enable AAA **authentication** for SSH.

```
(config)#aaa authentication ssh console LOCAL
```

Step 9: Enable AAA **authentication** for Enable mode.

```
(config)#aaa authentication enable console LOCAL
```

Step 10: Specify Privilege Level 15 for Crypto Officer and Privilege Level 1 for User and set up username/password for each role.

```
(config)#username <name> password <password> privilege 15  
(config)#username <name> password <password> privilege 1
```

Step 11: Ensure passwords are at least 8 characters long.

Step 12: All default passwords, such as enable and telnet, must be replaced with new passwords.

Step 13: Apply tamper evident labels as described in the “Physical Security” section on page 17.

Step 14: Reboot the security appliances.

3.2 Crypto Officer Guidance - System Configuration

To operate in FIPS mode, the Crypto Officer must perform the following steps:

Step 1: Assign users a Privilege Level of 1.

Step 2: Define RADIUS and TACACS+ shared secret keys that are at least 8 characters long and secure traffic between the security appliances and the RADIUS/TACACS+ server via IPsec tunnel.

Note: Perform this step only if RADIUS/TACAS+ is configured, otherwise proceed to step 3.

Step 3: Configure the TLS protocol when using HTTPS to protect administrative functions. Due to known issues relating to the use of TLS with certain versions of the Java plugin, we require that you upgrade to JRE 1.5.0_05 or later. The following configuration settings are known to work when launching ASDM in a TLS-only environment with JRE 1.5.0_05:

a. Configure the device to allow only TLSv1 packets using the following command:

```
(config)# ssl server-version tlsv1-only
```

```
(config)# ssl client-version tlsv1-only
```

b. Uncheck SSL Version 2.0 in both the web browser and JRE security settings.

c. Check TLS V1.0 in both the web browser and JRE security settings.

Step 4: Configure the security appliances to use SSHv2. Note that all operators must still authenticate after remote access is granted.

```
(config)# ssh version 2
```

Step 5: Configure the security appliances such that any remote connections via Telnet are secured through IPsec.

Step 6: Configure the security appliances such that only FIPS-approved algorithms are used for IPsec tunnels.

Step 7: Configure the security appliances such that error messages can only be viewed by Crypto Officer.

Step 8: Configure SNMP to always use a secure IPsec tunnel.

Step 9: Disable the TFTP server.

Step 10: Disable HTTP for performing system management in FIPS mode of operation. HTTPS with TLS should always be used for Web-based management.

Step 11: Ensure that installed digital certificates are signed using FIPS approved algorithms.

Step 12: Ensure that the 512-bit and 768-bit RSA keys are not used.

Step 13: Ensure that DH Group 1 (768-bits) keys are not used.

3.3 Identifying Router Operation in an Approved Mode

The following activities are required to verify that the module is operating in an Approved mode of operation.

1. Verify that the tamper evidence labels and FIPS opacity shields have been properly placed on the module based on the instructions specified in the “Physical Security” and “Secure Operation” sections of this document.

2. Verify that the length of User and Crypto Officer passwords and all shared secrets are at least eight (8) characters long, include at least one letter, and include at least one number character, as specified in the “Secure Operation” section of this document.
3. Issue the following commands: 'show crypto IPsec sa' and 'show crypto isakmp policy' to verify that only FIPS approved algorithms are used.

By printing or making a copy of this document, the user agrees to use this information for product evaluation purposes only. Sale of this information in whole or in part is not authorized by Cisco Systems.