

# FIPS 140-2 Security Policy

FortiGate-5140B Chassis with FortiGate-5001D Blade

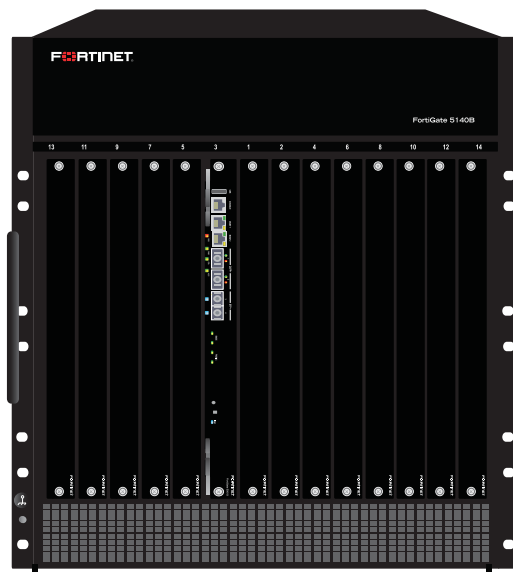

<i>FortiGate-5140B Chassis and FortiGate-5001D Blade FIPS 140-2 Security Policy</i>		
<b>Document Version:</b>	1.8	
<b>Publication Date:</b>	September 25, 2017	
<b>Description:</b>	Documents FIPS 140-2 Level 2 Security Policy issues, compliancy and requirements for FIPS compliant operation.	
<b>Firmware Version:</b>	FortiOS 5.2.7, build8982, 160328	
<b>Hardware Version:</b>	FortiGate-5001D (P1AB76)	Blank Filler Panel - Front (P10945-01)
	FortiGate-5140B (P09297-01)	Blank Filler Panel - Rear (P10946-01)
		Air Filter (P10938-01)

***FortiGate-5140B Chassis and FortiGate-5001D Blade FIPS 140-2 Security Policy***

01-525-372142-20160512

Copyright© 2017 Fortinet, Inc. All rights reserved. Fortinet®, FortiGate®, FortiCare® and FortiGuard®, and certain other marks are registered trademarks of Fortinet, Inc., in the U.S. and other jurisdictions, and other Fortinet names herein may also be registered and/or common law trademarks of Fortinet. All other product or company names may be trademarks of their respective owners. Performance and other metrics contained herein were attained in internal lab tests under ideal conditions, and actual performance and other results may vary. Network variables, different network environments and other conditions may affect performance results. Nothing herein represents any binding commitment by Fortinet, and Fortinet disclaims all warranties, whether express or implied, except to the extent Fortinet enters a binding written contract, signed by Fortinet's General Counsel, with a purchaser that expressly warrants that the identified product will perform according to certain expressly-identified performance metrics and, in such event, only the specific performance metrics expressly identified in such binding written contract shall be binding on Fortinet. For absolute clarity, any such warranty will be limited to performance in the same ideal conditions as in Fortinet's internal lab tests. In no event does Fortinet make any commitment related to future deliverables, features or development, and circumstances may change such that any forward-looking statements herein are not accurate. Fortinet disclaims in full any covenants, representations, and guarantees pursuant hereto, whether express or implied. Fortinet reserves the right to change, modify, transfer, or otherwise revise this publication without notice, and the most current version of the publication shall be applicable.

This document may be freely reproduced and distributed whole and intact including this copyright notice.

A decorative graphic in the bottom right corner of the page, consisting of a grid of light gray squares and rounded rectangles of varying sizes and orientations.

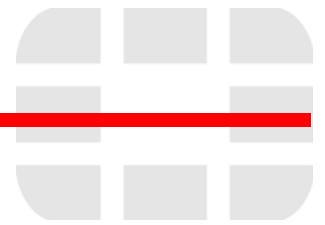

## Contents

Overview . . . . .	2
References . . . . .	2
Introduction . . . . .	2
Security Level Summary . . . . .	3
Module Descriptions . . . . .	3
Chassis Description . . . . .	4
Cryptographic Module Ports and Interfaces . . . . .	4
FortiGate-5001D Blade . . . . .	4
FortiGate-5140B Chassis . . . . .	7
Web-Based Manager . . . . .	8
Command Line Interface . . . . .	9
Roles, Services and Authentication . . . . .	9
Roles . . . . .	9
FIPS Approved Services . . . . .	10
Non-FIPS Approved Services . . . . .	11
Authentication . . . . .	11
Physical Security . . . . .	12
Operational Environment . . . . .	15
Cryptographic Key Management . . . . .	15
Random Number Generation . . . . .	15
Entropy Token . . . . .	15
Key Zeroization . . . . .	15
Algorithms . . . . .	16
Cryptographic Keys and Critical Security Parameters . . . . .	17
Alternating Bypass Feature . . . . .	19
Key Archiving . . . . .	20
Electromagnetic Interference/Electromagnetic Compatibility (EMI/EMC) . . . . .	20
Mitigation of Other Attacks . . . . .	20
FIPS 140-2 Compliant Operation . . . . .	21
Enabling FIPS-CC mode . . . . .	22
Self-Tests . . . . .	22

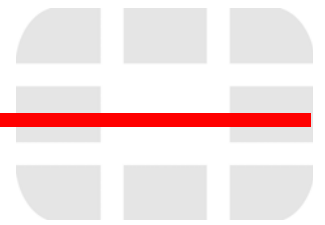

## Overview

This document is a FIPS 140-2 Security Policy for Fortinet Incorporated's FortiGate-5140B chassis with the FortiGate-5001D blade based Multi-Threat Security System. This policy describes how the FortiGate-5001D blade, when installed in the FortiGate-5140B chassis (hereafter referred to in combination as the 'module'), meet the FIPS 140-2 security requirements and how to operate the modules in a FIPS compliant manner. This policy was created as part of the Level 2 FIPS 140-2 validation of the module.

The Federal Information Processing Standards Publication 140-2 - *Security Requirements for Cryptographic Modules* (FIPS 140-2) details the United States Federal Government requirements for cryptographic modules. Detailed information about the FIPS 140-2 standard and validation program is available on the NIST (National Institute of Standards and Technology) website at <http://csrc.nist.gov/groups/STM/cmvp/index.html>.

## References

This policy deals specifically with operation and implementation of the modules in the technical terms of the FIPS 140-2 standard and the associated validation program. Other Fortinet product manuals, guides and technical notes can be found at the Fortinet technical documentation website at <http://docs.fortinet.com>.

Additional information on the entire Fortinet product line can be obtained from the following sources:

- Find general product information in the product section of the Fortinet corporate website at <http://www.fortinet.com/products>.
- Find on-line product support for registered products in the technical support section of the Fortinet corporate website at <http://www.fortinet.com/support>.
- Find contact information for technical or sales related questions in the contacts section of the Fortinet corporate website at <http://www.fortinet.com/contact>.
- Find security information and bulletins in the FortiGuard Center of the Fortinet corporate website at <http://fortiguard.com>.

## Introduction

The FortiGate product family spans the full range of network environments, from SOHO to service provider, offering cost effective systems for any size of application. FortiGate appliances detect and eliminate the most damaging, content-based threats from email and Web traffic such as viruses, worms, intrusions, inappropriate Web content and more in real time — without degrading network performance. In addition to providing application level firewall protection, FortiGate appliances deliver a full range of network-level services — VPN, intrusion prevention, web filtering, antivirus, antispam and traffic shaping — in dedicated, easily managed platforms.

All FortiGate appliances employ Fortinet's unique FortiASIC content processing chip and the powerful, secure, FortiOS firmware achieve breakthrough price/performance. The unique, ASIC-based architecture analyzes content and behavior in real time, enabling key applications to be deployed right at the network edge where they are most effective at protecting enterprise networks. They can be easily configured to provide antivirus protection, antispam protection and content filtering in conjunction with existing firewall, VPN, and related devices, or as complete network protection systems. The modules support High Availability (HA) in both Active-Active (AA) and Active-Passive (AP) configurations.

FortiGate appliances support the IPSec industry standard for VPN, allowing VPNs to be configured between a FortiGate appliance and any client or gateway/firewall that supports IPSec VPN. FortiGate appliances also provide SSL VPN services using TLS 1.2.

## Security Level Summary

The modules meets the overall requirements for a FIPS 140-2 Level 2 validation.

**Table 1: Summary of FIPS security requirements and compliance levels**

Security Requirement	Compliance Level
Cryptographic Module Specification	2
Cryptographic Module Ports and Interfaces	3
Roles, Services and Authentication	3
Finite State Model	2
Physical Security	2
Operational Environment	N/A
Cryptographic Key Management	2
EMI/EMC	2
Self-Tests	2
Design Assurance	3
Mitigation of Other Attacks	2

## Module Descriptions

The FortiGate-50010D is an ATCA, blade based, multiple chip, standalone cryptographic module consisting of production grade components contained in a physically protected enclosure in accordance with FIPS 140-2 Level 2 requirements.

The module runs the FortiOS firmware, performs all of the cryptographic functions and provides the input/output interfaces. The chassis provides power, cooling and physical protection for the module as a whole. The chassis does not run FortiOS firmware.

The module is an Internet device that provide integrated firewall, VPN, antivirus, antispam, intrusion prevention, content filtering and traffic shaping and HA capabilities. This FIPS 140-2 Security Policy specifically covers the firewall, IPSec and SSL-VPN capabilities of the module.

The antivirus, antispam, intrusion prevention, content filtering and traffic shaping capabilities of the modules can be used without compromising the FIPS approved mode of operation.

The FortiGate-5001D has 6 network interfaces with a status LED for each network interface (2x 40GB QSFP+, 2x 10GB SFP+, 2x 10/100/1000 Base-T).

The module has one x86 compatible CPU.

The validated firmware version is FortiOS v5.2.7,build8982,160328.

Figure 1 is representative of the module tested.

## Chassis Description

The FortiGate-5140B has 4 hot swappable, internal ventilation fan units that draw in air from the bottom front of the chassis and expel it from the top rear. These fans are excluded from the requirements of FIPS 140-2, as they perform no security relevant function.

The FortiGate-5140B uses two, hot-swappable, DC power entry modules (PEMs). These PEMs are outside the cryptographic boundary and only connect to the internal chassis power interface.

The FortiGate-5140B chassis uses an external DC power source.

The FortiGate-5140B chassis supports removable Shelf Managers (2) and Shelf Alarm (1) panels. These panels are outside the cryptographic boundary and only connect to the internal interface.

The FortiGate-5140B chassis includes slots for rear-panel blades. However, the rear panel slots are not populated in the validated configuration.

## Cryptographic Module Ports and Interfaces

### FortiGate-5001D Blade

Figure 1: FortiGate-5001D Front Panel

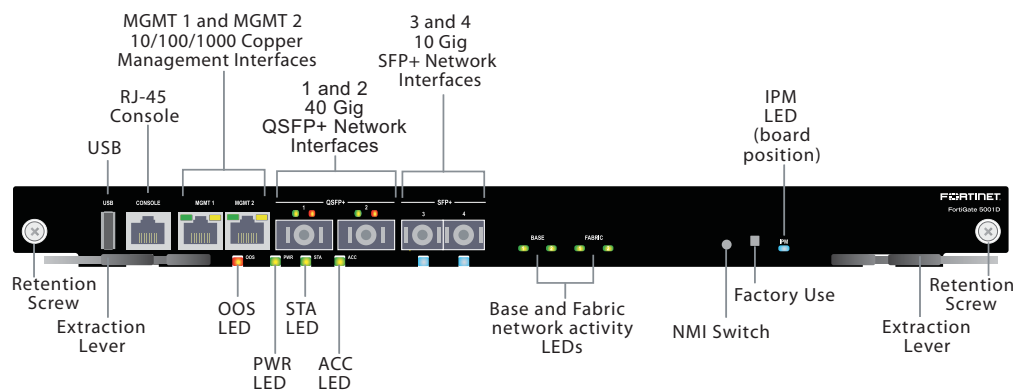

Table 2: FortiGate-5001D Status LEDs, Port 1 and 2, 40Gbit Mode

Green LED (left)	Amber LED (right)	Description
On	Off	The correct cable is connected to the interface and the connected equipment has power.
Off	Off	No link is established.

**Table 3: FortiGate-5001D Status LEDs, Port 1 and 2, 4x 10Gbit Mode**

Green LED (left)	Amber LED (right)	Description
Flashing	On	The correct cables are connected to the interface, the connected equipment has power and all 10Gbit interfaces are connected.
Flashing	Flashing	The correct cables are connected to the interface, the connected equipment has power and only some of the 10Gbit interfaces are connected.
Off	Off	No link is established.

**Table 4: Other FortiGate-5001D Status LEDs**

LED		State	Description
MGMT 1 and 2	Link/Act (Left LED)	Green	The correct cable is connected to the interface and the connected equipment has power.
		Blinking	Network activity at the interface.
		Off	No link is established.
	Speed (Right LED)	Green	Connected at 1 Gbps.
		Amber	Connected at 100 Mbps.
		Off	Connected at 10 Mbps.
Ports 3 and 4		Green	The correct cable is connected to the interface and the connected equipment has power.
		Flashing Green	Network activity at the interface.
		Off	No link is established.
Base 1 and 2		Green	Base backplane interface is connected at 1 Gbps.
		Flashing Green	Network activity at base backplane interface.
Fabric 1 and 2		Green	Fabric backplane interface is connected at 10 Gbps.
		Flashing Green	Network activity at fabric backplane interface.
ACC (Disk Activity)		Off or Flashing green	The ACC LED flashes green when the FortiGate-5001D blade accesses its internal storage. The storage contains the current FortiOS firmware build and configuration files. The system accesses the storage when starting up, during a firmware upgrade, or when an administrator is using the CLI or GUI to change the FortiOS configuration. Under normal operating conditions this LED flashes occasionally, but is mostly off.
OOS (Out of Service)		Off	Normal operation.
		Green	A fault condition exists and the FortiGate-5001D blade is out of service (OOS). This LED may also flash very briefly during normal startup.

PWR (Power)	Green	The FortiGate-5001D blade is powered on.
STA (Status)	Off	The FortiGate-5001D blade is powered on.
	Flashing	The FortiGate-5001D is starting up. If this LED is flashing at any time other than system startup, a fault condition may exist.
IPM	Blue	The FortiGate-5001D is ready to be hot-swapped (removed from the chassis). If the IPM light is blue and no other LEDs are lit the FortiGate-5001A blade has lost power.
	Flashing	The FortiGate-5001D is changing from hot swap to running mode or from running mode to hot swap.
	Off	Normal operation. The FortiGate-5001D blade is in contact with the chassis backplane.

Table 5: FortiGate-5001C Front Panel Connectors and Ports

Connector	Type	Speed	Supported Logical Interfaces	Description
Ports 1 and 2	QSFP+	40Gbps	Data input, data output, control input and status output	Connection to QSFP+ networks.
Ports 3 and 4	SFP+	10Gbps	Data input, data output, control input and status output	Connection to SFP+ networks.
MGMT1 and MGMT 2	RJ-45	10/100/1000 Base-T	Data input, data output, control input and status output	Connection to 10/100/1000 networks.
CONSOLE	RJ-45	9600 bps	Control input, status output	Optional connection to the management computer. Provides access to the command line interface (CLI).
USB Port	USB	N/A	Key loading and archiving, entropy input	Optional USB token and entropy token.



## FortiGate-5140B Chassis

Figure 2: FortiGate-5140B Front Panel

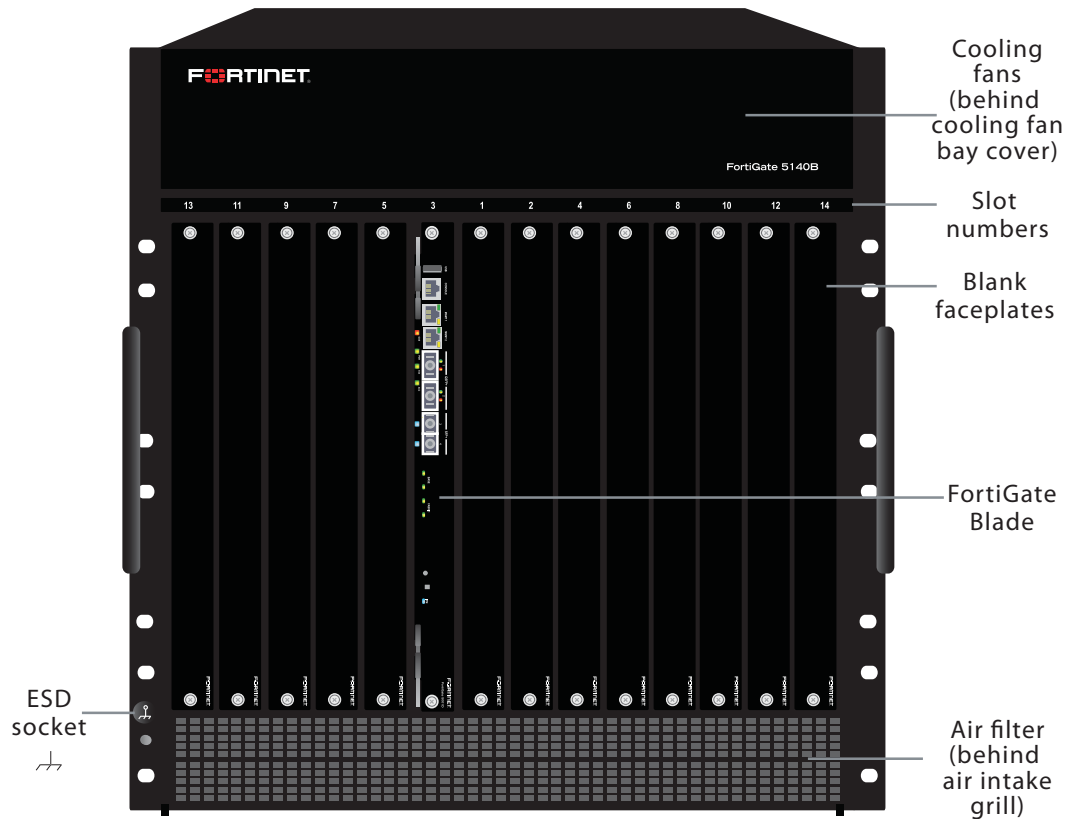
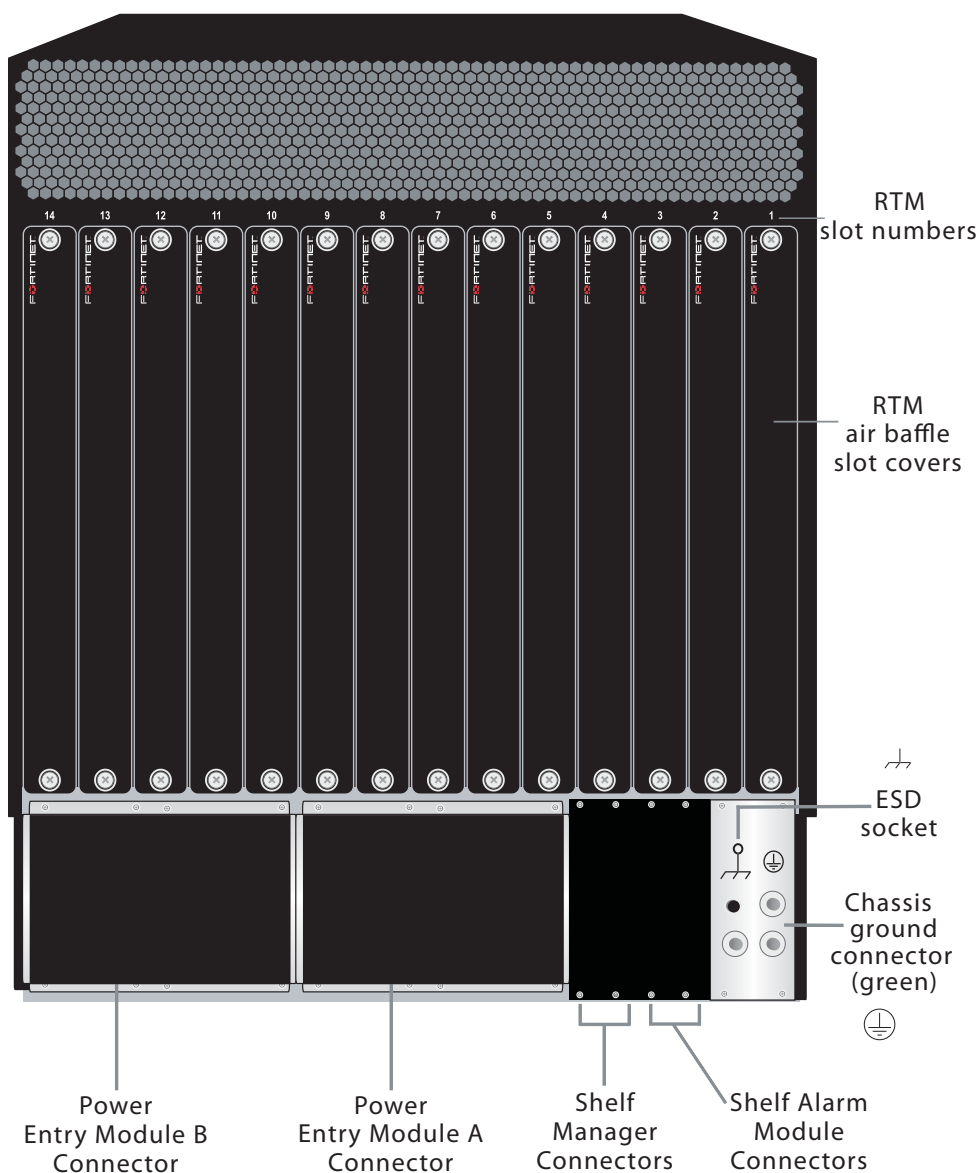

Figure 3: FortiGate-5140B Rear Panel



## Web-Based Manager

The FortiGate web-based manager provides GUI based access to the modules and is the primary tool for configuring the modules. The manager requires a web browser on the management computer and an Ethernet connection between the FortiGate unit and the management computer.

A web-browser that supports Transport Layer Security (TLS) 1.2 is required for remote access to the web-based manager when the module is operating in FIPS-CC mode. HTTP access to the web-based manager is not allowed in FIPS mode and is disabled.

Figure 4: The FortiGate web-based manager

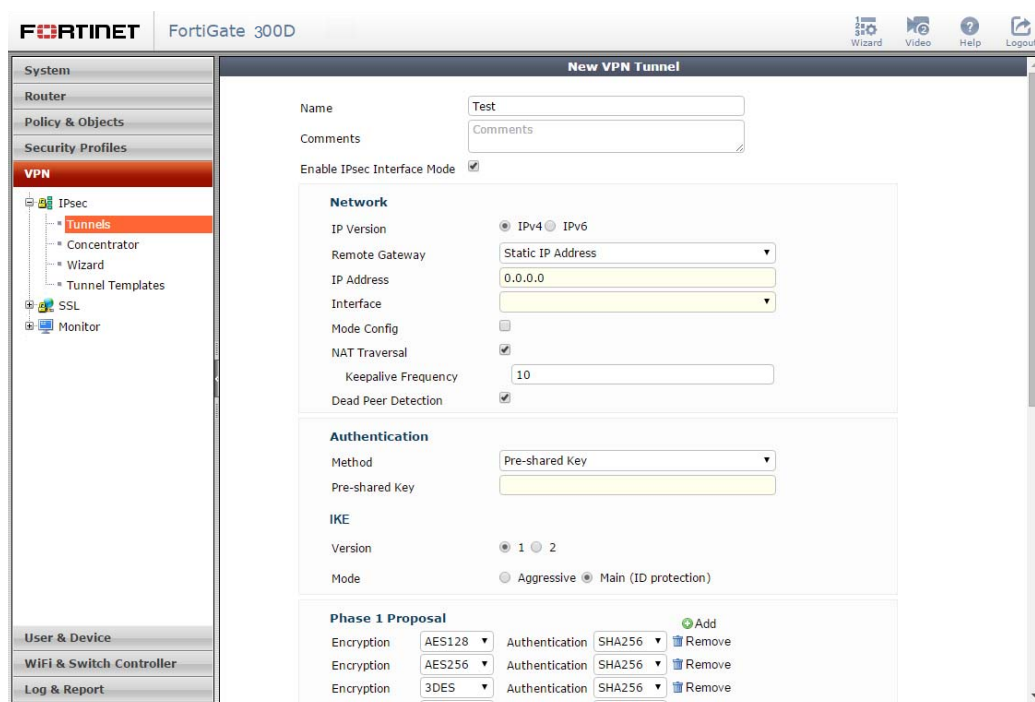

## Command Line Interface

The FortiGate Command Line Interface (CLI) is a full-featured, text based management tool for the module. The CLI provides access to all of the possible services and configuration options in the module. The CLI uses a console connection or a network (Ethernet) connection between the FortiGate unit and the management computer. The console connection is a direct serial connection. Terminal emulation software is required on the management computer using either method. For network access, a Telnet or SSH client that supports the SSH v2.0 protocol is required (SSH v1.0 is not supported in FIPS mode). Telnet access to the CLI is not allowed in FIPS mode and is disabled.

## Roles, Services and Authentication

### Roles

When configured in FIPS mode, the module provides the following roles:

- Crypto Officer
- Network User

The Crypto Officer role is initially assigned to the default 'admin' operator account. The Crypto Officer role has read-write access to all of the module's administrative services. The initial Crypto Officer can create additional operator accounts. These additional accounts are assigned the Crypto Officer role and can be assigned a range of read/write or read only access permissions including the ability to create operator accounts.

The modules also provide a **Network User** role for end-users (Users). Network Users can make use of the encrypt/decrypt services, but cannot access the modules for administrative purposes.

The module does not provide a Maintenance role.

## FIPS Approved Services

The following tables detail the types of FIPS approved services available to each role in each mode of operation, the types of access for each role and the Keys or CSPs they affect.

The access types are abbreviated as follows:

<b>Read Access</b>	R
<b>Write Access</b>	W
<b>Execute Access</b>	E

**Table 6: Services available to Crypto Officers**

Service	Access	Key/CSP
authenticate to module	WE	Operator Password, Diffie-Hellman Key, HTTP/TLS and SSH Server/Host Keys, HTTPS/TLS and SSH Session Authentication Keys, and HTTPS/TLS Session Encryption Keys, DRBG Output, DRBG Seed, DRBG Input String
show system status	WE	N/A
show FIPS-CC mode enabled/disabled (console/CLI only)	WE	N/A
enable FIPS-CC mode of operation (console only)	WE	Configuration Integrity Key
key zeroization	WE	All Keys, See <a href="#">"Key Zeroization" on page 15</a>
execute factory reset (disable FIPS-CC mode, console/CLI only)	E	All keys except firmware update key, configuration integrity key, configuration backup key
execute FIPS-CC on-demand self-tests (console only)	E	Configuration Integrity Key, Firmware Integrity Key
add/delete operators and network users	WE	Crypto Officer Password, Network User Password
set/reset operator and network user passwords	WE	Crypto Officer Password, Network User Password
backup/restore configuration file	WE	Configuration Encryption Key, Configuration Backup Key
read/set/delete/modify module configuration	WE	N/A
execute firmware update	E	Firmware Update Key
read log data	WE	N/A
delete log data (console/CLI only)	WE	N/A
execute system diagnostics (console/CLI only)	WE	N/A

**Table 6: Services available to Crypto Officers**

Service	Access	Key/CSP
enable/disable alternating bypass mode	WE	N/A
read/set/delete/modify IPSec/SSL VPN configuration	N/A	IPSec: IPSec Manual Authentication Key, IPSec Manual Encryption Key, IKE Pre-Shared Key, IKE RSA Key SSL: HTTPS/TLS Server/Host Key, HTTPS/TLS Session Authentication Key, HTTPS/TLS SSH Session Encryption Key
read/set/modify HA configuration	WE	HA Password, HA Encryption Key

**Table 7: Services available to Network Users in FIPS-CC mode**

Service/CSP	Access	Key/CSP
authenticate to module	WE	Network User Password, Diffie-Hellman Key, HTTPS/TLS Server/Host Key, HTTPS/TLS Session Authentication Key, HTTPS/TLS Session Encryption Key, DRBG Output, DRBG Seed, DRBG Input String
IPSec VPN controlled by firewall policies	E	Diffie-Hellman Key, IKE and IPSec Keys, DRBG Output, DRBG Seed, DRBG Input String
SSL VPN controlled by firewall policies	E	Network User Password, Diffie-Hellman Key, HTTPS/TLS Server/Host Key, HTTPS/TLS Session Authentication Key, HTTPS/TLS Session Encryption Key, DRBG Output, DRBG Seed, DRBG Input String

## Non-FIPS Approved Services

The module also provides the following non-FIPS approved services:

- Configuration backups using password protection
- LLTP and PPTP VPN

All services in [Table 6](#) and [Table 7](#) are considered non-approved when using the following algorithms:

- Non-compliant-strength Diffie-Hellman
- Non-compliant-strength RSA key wrapping
- DES
- MD5
- HMAC-MD5

## Authentication

The module implements identity based authentication. Operators must authenticate with a user-id and password combination to access the modules remotely or locally via the console. Remote operator authentication is done over HTTPS (TLS) or SSH. The password entry feedback mechanism does not provide information that could be used to guess or determine the authentication data.

By default, Network User access to the modules is based on firewall policy and authentication by IP address or fully qualified domain names. Network Users can optionally be forced to authenticate to the modules using a username/password combination to enable use of the IPSec VPN encrypt/decrypt or bypass services. For Network Users invoking the SSL-VPN encrypt/decrypt services, the modules support authentication with a user-id/password combination. Network User authentication is done over HTTPS and does not allow access to the modules for administrative purposes.

Note that operator authentication over HTTPS/SSH and Network User authentication over HTTPS are subject to a limit of 3 failed authentication attempts in 1 minute; thus, the maximum number of attempts in one minute is 3. Therefore the probability of a success with multiple consecutive attempts in a one-minute period is 3 in  $94^8$  which is less than 1/100,000.

Operator authentication using the console is not subject to a failed authentication limit, but the number of authentication attempts per minute is limited by the bandwidth available over the serial connection which is a maximum of 115,200 bps which is 6,912,000 bits per minute. An 8 byte password would have 64 bits, so there would be no more than 108,000 passwords attempts per minute. Therefore the probability of success would be  $1/(948/108,000)$  which is less than 1/100,000

The minimum password length is 8 characters when in FIPS-CC mode (maximum password length is 32 characters). The password may contain any combination of upper- and lower-case letters, numbers, and printable symbols; allowing for 94 possible characters. The odds of guessing a password are 1 in  $94^8$  which is significantly lower than one in a million. Recommended procedures to increase the password strength are explained in [“FIPS 140-2 Compliant Operation” on page 21](#).

For Network Users invoking the IPSec VPN encrypt/decrypt services, the module acts on behalf of the Network User and negotiates a VPN connection with a remote module. The strength of authentication for IPSec services is based on the authentication method defined in the specific firewall policy: IPSec manual authentication key, IKE pre-shared key or IKE RSA key (RSA certificate). The odds of guessing the authentication key for each IPSec method is:

- 1 in  $16^{40}$  for the IPSec Manual Authentication key (based on a 40 digit, hexadecimal key)
- 1 in  $94^8$  for the IKE Pre-shared Key (based on an 8 character, ASCII printable key)
- 1 in  $2^{112}$  for the IKE RSA Key (based on a 2048bit RSA key size)

Therefore the minimum odds of guessing the authentication key for IPSec is 1 in  $94^8$ , based on the IKE Pre-shared key.

## Physical Security

The modules meet FIPS 140-2 Security Level 2 requirements by using production grade components and an opaque, sealed enclosure. Access to the enclosure is restricted through the use of tamper-evident seals to secure the overall enclosure.

The seals are red wax/plastic with black lettering that reads “Fortinet Security Seal”.

The tamper seals are not applied at the factory prior to shipping. It is the responsibility of the Crypto Officer to apply the seals before use to ensure full FIPS 140-2 compliance. Once the seals have been applied, the Crypto Officer must develop an inspection schedule to verify that the external enclosure of the modules and the tamper seals have not been damaged or tampered with in any way. Upon viewing any signs of tampering, the Crypto Officer must assume that the device has been fully compromised. The Crypto Officer is required to zeroize the cryptographic module by following the steps in the Key Zeroization section of the SP. The Crypto Officer is also responsible for securing and controlling any unused seals.

The surfaces should be cleaned with 99% Isopropyl alcohol to remove dirt and oil before applying the seals. Ensure the surface is completely clean and dry before applying the seals. If a seal needs to be re-applied, completely remove the old seal and clean the surface with an adhesive remover before following the instructions for applying a new seal.

Additional seals can be requested through your Fortinet sales contact. Reference the 'FIPS-SEAL-RED' SKU when ordering. Specify the number of seals required based on the specific model as described below:

The FortiGate-5140B uses 24 seals to secure:

- the front panel cooling fan bay cover (2 seals, see [Figure 5](#) and [Figure 6](#)),
- the front panel blades and blank face plates (7 seals, see [Figure 5](#)),
- the front panel air intake bezel (2 seals, see [Figure 5](#) and [Figure 6](#)),
- the rear panel blank face plates (13 seals, see [Figure 6](#)).

**Figure 5: FortiGate-5140B front seals**

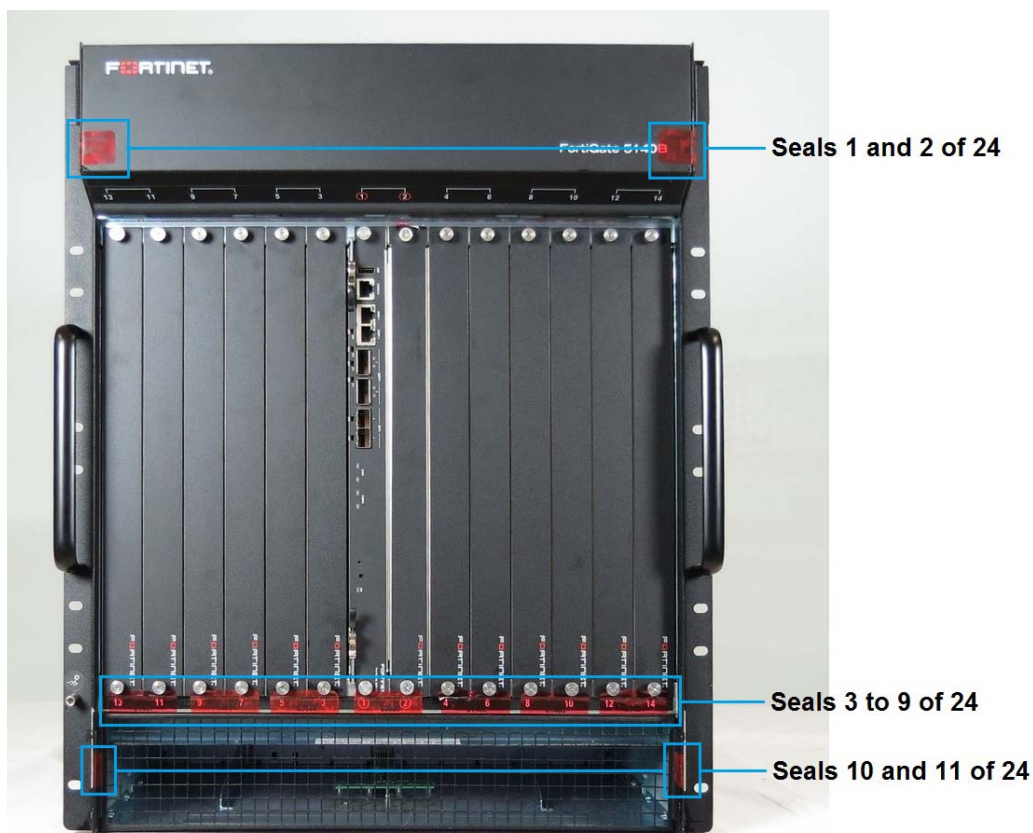



Figure 6: FortiGate-5140B front seals, side view

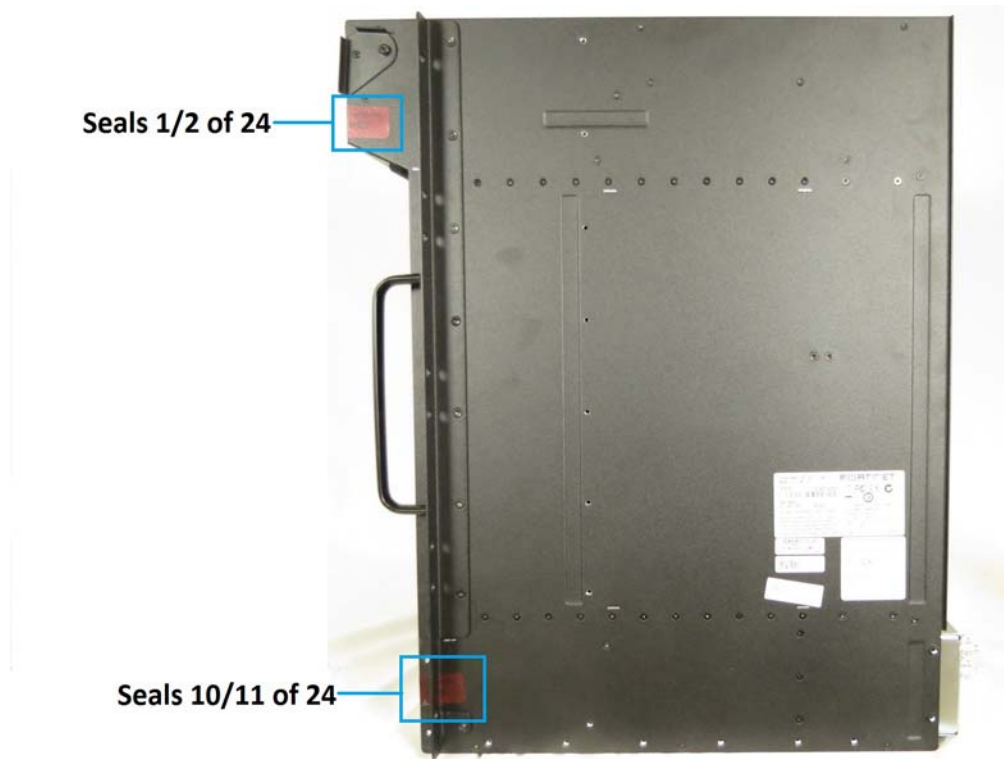

Figure 7: FortiGate-5140B rear seals





## Operational Environment

The modules consist of the combination of the FortiOS operating system and the FortiGate appliances. The FortiOS operating system can only be installed, and run, on a FortiGate appliance. The FortiOS operating system provides a proprietary and non-modifiable operating system.

## Cryptographic Key Management

### Random Number Generation

The modules use a firmware based, deterministic random bit generator (DRBG) that conforms to NIST Special Publication 800-90A. The Module generates cryptographic keys whose strengths are modified by available entropy. There is no assurance of the minimum strength of generated keys.

### Entropy Token

The modules use a Fortinet entropy token (part number FTR-ENT-1 or part number FTR-ENT-2) to seed the DRBG during the modules' boot process and to periodically reseed the DRBG. The entropy token is not included in the boundary of the module and therefore no assurance can be made for the correct operation of the entropy token nor is there a guarantee of stated entropy.

The default reseed period is once every 24 hours (1440 minutes). The entropy token must be installed to complete the boot process and to reseed the DRBG. The entropy token is responsible for loading a minimum of 256 bits of entropy.

### Key Zeroization

The zeroization process must be performed under the direct control of the operator. The operator must be present to observe that the zeroization method has completed successfully.

All keys and CSPs are zeroized by erasing the module's boot device and then power cycling the FortiGate unit. To erase the boot device, execute the following command from the CLI:

```
execute erase-disk <boot device>
```

The boot device ID may vary depending on the FortiGate module. Executing the following command will output a list of the available internal disks:

```
execute erase-disk ?
```

## Algorithms

**Table 8: FIPS Approved Algorithms**

Algorithm	NIST Certificate Number
CTR DRBG (NIST SP 800-90A) with 256-bits	1161
Triple-DES in CBC mode with 192-bits	2172, 2173, 2175
AES in CBC mode (128-, 192-, 256-bits)	3963, 3964, 3966
SHA-1	3267, 3268, 3270
SHA-256	3267, 3268, 3270
HMAC SHA-1	2581, 2582, 2584
HMAC SHA-256	2581, 2582, 2584
RSA PKCS1 -Signature Generation: 2048-bit -Signature Verification: 1024 and 2048-bit -For legacy use, the module supports 1024-bit RSA keys and SHA-1 for signature verification	2026
RSA PKCS1 -Signature Generation: 2048 and 3072-bit -Signature Verification: 1024, 2048 and 3072-bit -For legacy use, the module supports 1024-bit RSA keys and SHA-1 for signature verification	2024
CVL (SSH) - with TDES-192 bit-CBC, AES 128 bit-, AES 256 bit -CBC (using SHA1)	794
CVL (TLS) - TLS 1.1 and 1.2	794
CVL (IKE v1 and v2)	795

**Table 9: FIPS Allowed Algorithms**

Algorithm
RSA (key wrapping; key establishment methodology provides 112 or 128 bits of encryption strength)
Diffie-Hellman (key agreement; key establishment methodology provides between 112 and 201 bits of encryption strength)
NDRNG (Entropy Token) - please refer to the <a href="#">"Entropy Token"</a> on page 15 for additional information.

**Table 10: FIPS Non-Compliant Algorithms**

Algorithm
SHA-384
SHA-512
HMAC SHA-384
HMAC SHA-512

Note that the algorithms in [Table 10](#) are listed as non-compliant since Known Answer Tests for the algorithms are not implemented in the validated firmware build.

**Table 11: Non-FIPS Allowed Algorithms**

Algorithm
DES (disabled in FIPS-CC mode)
MD5 (disabled in FIPS-CC mode)
HMAC-MD5 (disabled in FIPS-CC mode)
RSA is non-compliant when keys less than 2048 bits are used, since such keys do not provide the minimum required 112 bits of encryption strength.
Diffie-Hellman is non-compliant when keys less than 2048 bits are used, since such keys do not provide the minimum required 112 bits of encryption strength.

Note that the IKE, SSH and TLS protocols have not been tested by the CMVP or CAVP as per FIPS 140-2 Implementation Guidance D.11.

## Cryptographic Keys and Critical Security Parameters

The following table lists all of the cryptographic keys and critical security parameters used by the modules. The following definitions apply to the table:

<b>Key or CSP</b>	The key or CSP description.
<b>Storage</b>	Where and how the keys are stored
<b>Usage</b>	How the keys are used
<b>Zeroization</b>	The key zeroization method

**Table 12: Cryptographic Keys and Critical Security Parameters used in FIPS-CC mode**

Key or CSP	Generation	Storage	Usage	Zeroization
NDRNG output string	Automatic	Boot device Plain-text	Input string for the entropy pool	By erasing the Boot device and power cycling the module
DRBG seed	Automatic	Boot device Plain-text	Seed used by the DRBG (output from NDRNG)	By erasing the Boot device and power cycling the module
DRBG output	Automatic	Boot device Plain-text	Random numbers used in cryptographic algorithms	By erasing the Boot device and power cycling the module
DRBG v and key values	Automatic	Boot device Plain-text	Internal state values for the DRBG	By erasing the Boot device and power cycling the module
IPSec Manual Authentication Key	Manual	Boot device AES encrypted	Used as IPSec Session Authentication Key	By erasing the Boot device and power cycling the module
IPSec Manual Encryption Key	Automatic	SDRAM Plain-text	Used as IPSec Session Encryption Key	By erasing the Boot device and power cycling the module
IPSec Session Authentication Key	Automatic	SDRAM Plain-text	IPSec peer-to-peer authentication using HMAC SHA-1 or HMAC SHA-256	By erasing the Boot device and power cycling the module
IPSec Session Encryption Key	Automatic	SDRAM Plain-text	VPN traffic encryption/decryption using Triple-DES or AES	By erasing the Boot device and power cycling the module

**Table 12: Cryptographic Keys and Critical Security Parameters used in FIPS-CC mode**

Key or CSP	Generation	Storage	Usage	Zeroization
IKE Pre-Shared Key	Manual	Boot device AES encrypted	Used to generate IKE protocol keys	By erasing the Boot device and power cycling the module
IKE Authentication Key	Automatic	SDRAM Plain-text	IKE peer-to-peer authentication using HMAC SHA-1 , -256, -384 or -512 (SKEYID_A)	By erasing the boot device and power cycling the module
IKE Key Generation Key	Automatic	SDRAM Plain-text	IPSec SA keying material (SKEYID_D)	By erasing the boot device and power cycling the module
IKE Session Encryption Key	Automatic	SDRAM Plain-text	Encryption of IKE peer-to-peer key negotiation using Triple-DES or AES (SKEYID_E)	By erasing the boot device and power cycling the module
IKE RSA Key	Manual	Boot device Plain text	Used to generate IKE protocol keys	By erasing the boot device and power cycling the module
Diffie-Hellman Keys	Automatic	SDRAM Plaintext	Key agreement and key establishment	By erasing the boot device and power cycling the module
Firmware Update Key	Preconfigured	Boot device Plain-text	Verification of firmware integrity when updating to new firmware versions using RSA public key (firmware load test)	By erasing the boot device and power cycling the module
Firmware Integrity Key	Preconfigured	Boot device Plain-text	Verification of firmware integrity in the firmware integrity test using RSA public key (firmware integrity test)	By erasing the boot device and power cycling the module
HTTPS/TLS Server/Host Key	Preconfigured	Boot device Plain-text	RSA private key used in the HTTPS/TLS protocols (key establishment)	By erasing the boot device and power cycling the module
HTTPS/TLS Session Authentication Key	Automatic	SDRAM Plain-text	HMAC SHA-1, -256 or -384 key used for HTTPS/TLS session authentication	By erasing the boot device and power cycling the module
HTTPS/TLS Session Encryption Key	Automatic	SDRAM Plain-text	AES or Triple-DES key used for HTTPS/TLS session encryption	By erasing the boot device and power cycling the module
SSH Server/Host Key	Preconfigured	Boot device Plain-text	RSA private key used in the SSH protocol (key establishment)	By erasing the boot device and power cycling the module
SSH Session Authentication Key	Automatic	SDRAM Plain-text	HMAC SHA-1 or HMAC SHA-256 key used for SSH session authentication	By erasing the boot device and power cycling the module
SSH Session Encryption Key	Automatic	SDRAM Plain-text	AES or Triple-DES key used for SSH session encryption	By erasing the boot device and power cycling the module

**Table 12: Cryptographic Keys and Critical Security Parameters used in FIPS-CC mode**

Key or CSP	Generation	Storage	Usage	Zeroization
Crypto Officer Password	Manual	Boot device SHA-1 hash	Used to authenticate operator access to the module	By erasing the boot device and power cycling the module
Configuration Integrity Key	Preconfigured	Boot device Plain-text	HMAC SHA-256 hash used for configuration integrity test	By erasing the boot device and power cycling the module
Configuration Encryption Key	Automatic	Boot device Plain-text	AES key used to encrypt CSPs on the Boot device and in the backup configuration file (except for crypto officer passwords in the backup configuration file)	By erasing the boot device and power cycling the module
Configuration Backup Key	Automatic	Boot device Plain-text	HMAC SHA-256 key used to encrypt crypto officer passwords in the backup configuration file	By erasing the boot device and power cycling the unit
Network User Password	Manual	Boot device SHA-1 hash	Used to authenticate network access to the module	By erasing the boot device and power cycling the unit
HA Password	Manual	Boot device AES encrypted	Used to authenticate FortiGate units in an HA cluster	By erasing the boot device and power cycling the unit
HA Encryption Key	Manual	Boot device AES encrypted	Encryption of traffic between units in an HA cluster using AES	By erasing the boot device and power cycling the unit

**Note:** The Generation column lists all of the keys/CSPs and their entry/generation methods. Manual entered keys are entered by the operator electronically (as defined by FIPS) using the console or a management computer. Pre-configured keys are set as part of the firmware (hardcoded) and are not operator modifiable. Automatic keys are generated as part of the associated protocol.

## Alternating Bypass Feature

The primary cryptographic function of the module is as a firewall and VPN device. The module implements two forms of alternating bypass for VPN traffic: policy based (for IPSec and SSL VPN) and interface based (for IPSec VPN only).

### Policy Based VPN

Firewall policies with an action of IPSec or SSL-VPN mean that the firewall is functioning as a VPN start/end point for the specified source/destination addresses and will encrypt/decrypt traffic according to the policy. Firewall policies with an action of allow mean that the firewall is accepting/sending plaintext data for the specified source/destination addresses.

A firewall policy with an action of accept means that the module is operating in a bypass state for that policy. A firewall policy with an action of IPSec or SSL-VPN means that the module is operating in a non-bypass state for that policy.

### Interface Based VPN

Interface based VPN is supported for IPsec only. A virtual interface is created and any traffic routed to the virtual interface is encrypted and sent to the VPN peer. Traffic received from the peer is decrypted. Traffic through the virtual interface is controlled using firewall policies. However, unlike policy based VPN, the action is restricted to Accept or Deny and all traffic controlled by the policy is encrypted/decrypted.

When traffic is routed over the non-virtual interfaced, the module is operating in a bypass state. When traffic is routed over the virtual interface, the module is operating in a non-bypass state.

In both cases, two independent actions must be taken by a CO to create bypass firewall policies: the CO must create the bypass policy and then specifically enable that policy.

### Key Archiving

The module supports key archiving to a management computer as part of the module configuration file backup. Operator entered keys are archived as part of the module configuration file. The configuration file is stored in plain text, but keys in the configuration file are either AES encrypted using the Configuration Encryption Key or stored as a keyed hash using HMAC SHA-256 using the Configuration Backup Key.

## Electromagnetic Interference/Electromagnetic Compatibility (EMI/EMC)

The modules comply with EMI/EMC requirements for Class A or B devices as specified by Part 15, Subpart B, of the FCC rules. The following table lists the specific lab and report information for the modules.

**Table 13: FCC Report Information**

Module	Lab Information	FCC Report Number
FG-5001D	The module is declared to conform with EMI/EMC requirements for Class A devices as specified by Part 15, Subpart B, of the FCC rules.	N/A
FG-5140B	MET Labs 3162 Belick St. Santa Clara, CA 95054 CA (408) 748-3585	EMCS34777

## Mitigation of Other Attacks

The module includes a real-time Intrusion Prevention System (IPS) as well as antivirus protection, antispam and content filtering. Use of these capabilities is optional.

The FortiOS IPS has two components: a signature based component for detecting attacks passing through the FortiGate appliance and a local attack detection component that protects the firewall from direct attacks. Functionally, signatures are similar to virus definitions, with each signature designed to detect a particular type of attack. The IPS signatures are updated through the FortiGuard IPS service. The IPS engine can also be updated through the FortiGuard IPS service.

FortiOS antivirus protection removes and optionally quarantines files infected by viruses from web (HTTP), file transfer (FTP), and email (POP3, IMAP, and SMTP) content as it passes through the FortiGate modules. FortiOS antivirus protection also controls the blocking of oversized files and supports blocking by file extension. Virus signatures are updated through the FortiGuard antivirus service. The antivirus engine can also be updated through the FortiGuard antivirus service.

FortiOS antispam protection tags (SMTP, IMAP, POP3) or discards (SMTP only) email messages determined to be spam. Multiple spam detection methods are supported including the FortiGuard managed antispam service.

FortiOS web filtering can be configured to provide web (HTTP) content filtering. FortiOS web filtering uses methods such as banned words, address block/exempt lists, and the FortiGuard managed content service.

Whenever a IPS, antivirus, antispam or filtering event occurs, the modules can record the event in the log and/or send an alert email to an operator.

For complete information refer to the FortiGate Installation Guide for the specific module in question, the FortiGate Administration Guide and the FortiGate IPS Guide.

## FIPS 140-2 Compliant Operation

FIPS 140-2 compliant operation requires both that you use the module in its FIPS-CC mode of operation and that you follow secure procedures for installation and operation of the FortiGate unit. You must ensure that:

- The FortiGate unit is configured in the FIPS-CC mode of operation.
- The FortiGate unit is installed in a secure physical location.
- Physical access to the FortiGate unit is restricted to authorized operators.
- The Fortinet entropy token is used to seed the RBG.
- The Fortinet entropy token remains in the USB port during operation
- Administrative passwords are at least 8 characters long.
- Administrative passwords are changed regularly.
- Administrator account passwords must have the following characteristics:
  - One (or more) of the characters must be capitalized
  - One (or more) of the characters must be numeric
  - One (or more) of the characters must be non alpha-numeric (e.g. punctuation mark)
- Administration of the module is permitted using only validated administrative methods. These are:
  - Console connection
  - Web-based manager via HTTPS
  - Command line interface (CLI) access via SSH
- Diffie-Hellman groups of less than 2048 bits are not used.
- Client side RSA certificates must use 2048 bit or greater key sizes.
- Only approved and allowed algorithms are used (see [“Algorithms” on page 16](#)).

The module can be used in either of its two operation modes: NAT/Route or Transparent. NAT/Route mode applies security features between two or more different networks (for example, between a private network and the Internet). Transparent mode applies security features at any point in a network. The current operation mode is displayed on the web-based manager status page and in the output of the `get system status` CLI command.

## Enabling FIPS-CC mode

To enable the FIPS 140-2 compliant mode of operation, the operator must execute the following command from the Local Console:

```
config system fips-cc
  set entropy-token enable
  set status enable
end
```

The Operator is required to supply a password for the admin account which will be assigned to the Crypto Officer role.

The supplied password must be at least 8 characters long and correctly verified before the system will restart in FIPS-CC mode.

Upon restart, the module will execute self-tests to ensure the correct initialization of the module's cryptographic functions.

After restarting, the Crypto Officer can confirm that the module is running in FIPS-CC mode by executing the following command from the CLI:

```
get system status
```

If the module is running in FIPS-CC mode, the system status output will display the line:

```
FIPS-CC mode: enable
```

## Self-Tests

The module executes the following self-tests during startup and initialization:

- Firmware integrity test using RSA signatures
- Configuration/VPN bypass test using HMAC SHA-256
- Triple-DES, CBC mode, encrypt known answer test
- Triple-DES, CBC mode, decrypt known answer test
- AES, CBC mode, encrypt known answer test
- AES, CBC mode, decrypt known answer test
- HMAC SHA-1 known answer test
- SHA-1 known answer test (tested as part of HMAC SHA-1 known answer test)
- HMAC SHA-256 known answer test
- SHA-256 known answer test (tested as part of HMAC SHA-256 known answer test)
- RSA signature generation known answer test
- RSA signature verification known answer test
- DRBG known answer test

The results of the startup self-tests are displayed on the console during the startup process. The startup self-tests can also be initiated on demand using the CLI command **execute fips kat all** (to initiate all self-tests) or **execute fips kat <test>** (to initiate a specific self-test).

When the self-tests are run, each implementation of an algorithm is tested - e.g. when the AES self-test is run, all AES implementations are tested.

The module executes the following conditional tests when the related service is invoked:

- Continuous NDRNG test
- Continuous DRBG test



- RSA pairwise consistency test
- Configuration integrity test using HMAC SHA-256
- Firmware load test using RSA signatures

If any of the self-tests or conditional tests fail, the module enters an error state as shown by the console output below:

```
Self-tests failed
Entering error mode...
The system is going down NOW !!
The system is halted.
```

All data output and cryptographic services are inhibited in the error state.